

millboard

Live. Life. **Outside.**



Envello Cladding Installation guide

EN - UK

Board & Batten⁺ - Horizontal



Contents page

Easily find your way around the Millboard Envello Cladding installation guide for Board & Batten⁺ - Horizontal

About Millboard	4-5
Product Suitability	6
Intended uses & limitations	6
Pre-installation	7-9
Storage & handling	7
Tools & PPE required	8
Cutting	9
Fire performance	9
Materials	10-15
Colour characteristics	10
Material Calculator	11
Cladding boards & accessories	12-15
Preparation	16-19
Ventilation	17
Cladding support	18-19
Installation	20-23
Corners of buildings	20-21
Joining corner trims	21
Details around windows & doors	22-23
Starter trims	24
Fixings	24
Joining boards & profiles	25
Installation abutting render	26
Aftercare	27



About Envello cladding

A closer look

Envello cladding uses a unique material, unrivalled across the globe. Take a closer look at the construction and performance of this stunning yet functional cladding.



Tough

The unique surface layer is more resistant to scratches and stains and is designed to better withstand demanding outdoor environments.

Enduring

The dual-tone surface layer is hand tinted using pigments designed to improve resistance to sun damage and fading.

Beautiful

Each length is hand moulded using specially selected timber masters for an unrivalled organic wood-grain appearance in a composite material.

Fire rated

Board & Batten+ is fire rated to Euroclass D (BS EN 13501-1) for added assurance and quality.

Wood-free

Millboard cladding is wood-free and non-porous which, in comparison to timber, means there's no leaching or releasing of tannins to other surfaces

Durable

Millboard will not split, rot or harbour insects like timber does

Lightweight

Our unique closed 'cellular' internal structure reduces weight while maintaining strength and increasing thermal performance.

Stronger

The structural core is a blend of natural minerals bonded in a polymer resin with renewable biopolymers and fibre reinforcement for added strength and durability.



The Board & Batten+ has been moulded from four individual pieces of timber with different widths and grain patterns, creating a truly unique balance for both contemporary and traditional designs. With a tongue and groove profile that only requires fixings through the tongue, the install time is dramatically reduced compared to the traditional method of batten-on-board cladding with timber.

The profiles on the Board & Batten+ are designed with differing angles to create shadow definition between the grain patterns, as well as facilitating drainage when used horizontally. The increased thickness of the Board & Batten+ provides superior impact resistance.



Hand moulded and coloured
Skilfully moulded by hand and authentically coloured, replicating timber in the most realistic way.



Impact and weather resistant
A durable coating and elastomeric surface ensures increased resilience against hail and natural weathering.



Moisture resistant
Due to Envello's non-porous composition, no sealing is required, unlike other available products.



Easy to install
No specialist tools required, Envello can be cut and installed in the same way as traditional timber.



UV stability
UV stabilised for better performance and fade resistance over time.



Wood free
Envello is solid, not hollow, making it strong. This means it will not rot or warp like timber.



Increased thermal performance
The unique composition helps to enhance the thermal performance of buildings in both winter and summer.



Fire rated system
Certified to a Euroclass D rating (BS EN 13501-1) by a UKAS accredited laboratory, when fitted in accordance with our installation guide.

Crafted to be perfectly imperfect

Each length of Millboard cladding is the result of a long process of craftsmanship and attention to visual detail. Just like the specially selected Oak timbers used to create the unique moulds, the fine details and natural imperfections in the original material has to be recreated in the highly durable millboard product.

From the initial laying of the elastomeric surface, right through to the pouring of the fibre-reinforced resin mineral, we focus on achieving the quality of finish, reflecting the true random and natural characteristics of the original timber. Our mission is to accurately reproduce the original whilst adding all the benefits of our unique board technology, this is why many of our processes are carried out manually. For example, each piece is hand coloured to establish the authentic wood finish our boards are renowned for.

Product Suitability

Intended Use

Envello Cladding has been designed for beauty, longevity and ease of installation on residential and low-rise buildings. However, to ensure the best installation and long-term performance, we recommend that a professional trades person carries out the installation.

Millboard recommend that all cladding designs are approved by a licensed architect or engineer prior to installation. It is the property owner's responsibility to make sure that your plans meet any relevant local building regulations before the installation begins. Envello Cladding must be supported by a suitable substructure that is in accordance with building regulations.

Envello Cladding is a rainscreen cladding system which can be described as 'A wall comprising an outer skin of cladding boards and an airtight insulated backing wall separated by a ventilated cavity. Some water may penetrate into the cavity but the rainscreen cladding is intended to provide protection from direct rain'. Therefore, a well ventilated, free draining cavity should always be included in the detailed design.

It is not recommended to use Envello Cladding in structural applications, as it would need to be fixed to a structural frame of battens.

Limitations

This installation guide is not exhaustive as the responsibility for design lies with the specifier or responsible party for the project, to ensure the final design meets the requirements of the intended application and Building regulations.

For designs outside the scope of this installation guide, specific design must be undertaken by an architect or designer.

If in doubt, we would strongly recommend contacting Millboard pre-design stage to arrive at a suitable, robust, efficient solution and to avoid disappointment.

It is the responsibility of designers, installers, and owners to ensure that the information in this manual is current, by checking with Millboard or referring to our website. As new technology is introduced or industry standards are altered, Millboard reserves the right to alter existing specifications and remove products without notice. Visit our website on: www.millboard.co.uk

The use of this manual: does not guarantee acceptance or accreditation of a design, material or building solution by any entity authorised to do so under law; does not mean that a design, material or building solution complies with the building regulation; or does not absolve the user from complying with any local, or Government legal requirements.

Pre-Installation

Storage and Handling

Envello Cladding boards should always be stored on a flat surface or level bearers a maximum of 400mm apart and stacked face-to-face, not back-to-face. The Envello Square Corner Trims should be fully supported along their length.

When loading and unloading by hand, make sure that both ends are lifted on the edge to avoid permanent deformation and/or damage to the boards.

They should only be lifted off the stack, and not dragged as this could cause abrasion or marking on the surface.

Wear gloves and long sleeves when handling the boards and take care when lifting them. We recommend that two people carry the boards, they should be carried on their side for increased rigidity.

We advise that the cladding planks are stored on site at least 72 hours before installation, to allow the boards to climatize. Only move the pallet if the boards are safely strapped to it.

Millboard cannot be held responsible for damage caused by improper storage and handling of the product.

Tolerances:

There will always be a slight variance in the board's dimensions due to the fact that we mould from natural oak, and due to the pressure of the moulding process. Despite this, we calibrate the boards to maintain as consistent a profile as possible.

The manufacturing tolerances are: Width: ± 2 mm. Length: ± 5 mm. Thickness: ± 2 mm.

When working with the boards, a level may be required to help keep the boards running level or upright.

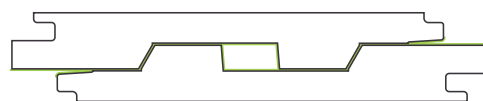

Stack boards face-to-face

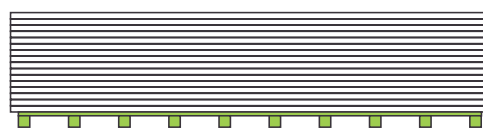

Ensure boards are on a flat surface or bearers max. 400mm apart

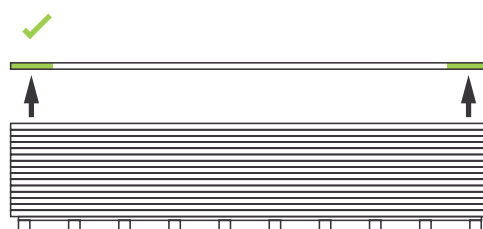

Lift boards on the edges using 2 people to lift at a time

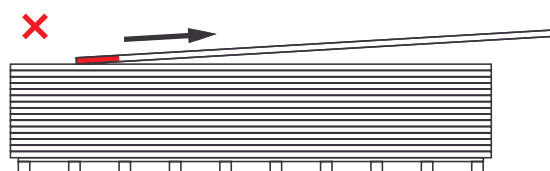

Do not drag the boards off the stack

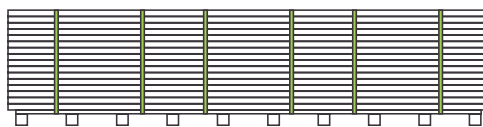

Ensure boards are secured to the pallet before transporting

Tools & PPE required

The tools and PPE you will need to install Envello Cladding.

If you are unsure on how to use any tools, please consult the tool's manufacturer's user manual.



Mitre saw/jigsaw/handsaw
Envello Cladding products can be cut with standard wood cutting tools (i.e. mitre saw, jigsaw, handsaw). We recommend using a carbon-tipped saw blade. An aluminium cutting blade should be used for the metal trims.



Personal Protective Equipment
When handling Millboard products, it is advised to wear long sleeves and gloves. When cutting products it is advised to wear a FFP3 dustmask, ear defenders and safety glasses.



Tool set
Standard carpentry tools will be needed to complete the installation, including: tape measure, a pencil, set square, planer, stanley knife, surform and a drill bit set.



Power drill and driver
Standard power drill drivers can be used to fix the cladding products. 2nd fix nailer can be used with Stainless Steel brads when the board tongue is taken off.



Spirit level
A spirit level is used to ensure that the battens are upright and the starter trims are level.



Laser level/line
If available, a laser level can be used to ensure the starter trims are installed level.

Cutting

Envello products can be cut with standard wood cutting tools (i.e. mitre saw, jigsaw, handsaw), we recommend a carbon-tipped saw blade. An aluminium cutting blade should be used for the metal trims.

When cutting the boards, wear an FFP3 dust mask, safety glasses, long sleeves and protective gloves.

A dust bag or vacuum must be used on mitre saws.

Make sure that the boards are adequately supported when cutting. Boards can be cut face-up or face-down.

When the board is cut, Touch-up Coating should be used if the cut will be visible and exposed to UV.

Dispose of board off-cuts by disposing as general waste or sending to a municipal incinerator for energy replenishment, don't burn them at home.

Fire Performance

Millboard Envello Board & Batten⁺ cladding boards are crafted with fire retardants in the board composition, they have been tested to BS EN 13501-1 and have a classification of D-s3, d0.

In general, Board & Batten⁺ cladding can be used on low-rise residential and some commercial properties that are below 11m in height and are more than 1m from the boundary.

The responsibility for the cladding's suitability in the required location is to be determined by a certified building professional (building control, building insurance, fire officer, etc).

Millboard will not be held responsible for incorrect specification, application, or product installation in areas not in accordance with government guidance, in the UK or abroad.

Current guidance should be gained from the government website relating to the geographical project location, England's building regulation Approved Document B can be found on -

<https://www.gov.uk/government/publications/fire-safety-approved-document-b>

Tip:

If there is a breeze/wind when cutting the boards, locate the saw up wind so that excess dust is blown away from the operator & project.



Materials

Colour Characteristics

We go to extraordinary lengths to recreate the look of natural products and therefore intentionally add secondary toning colours. This painstaking process means that there may be variance within the same board or between boards.

Envello Cladding has been designed to replicate the natural variances of timber and is manufactured to have tonal variance in the colour.

Buying all the Millboard you need at the same time should help to ensure that the colour is consistent. If you do have multiple batches then it is best to mix the boards, to create an effective, subtle blend.

Antique Oak boasts more tonal variation per individual board than any of the other colours in the Millboard range.

As with all products exposed to the Sunlight (UV), Millboard will naturally weather and tone down over time. Loss of gloss is perfectly normal and will not affect the performance of the products.

Millboard takes great care ensuring the performance of its products maintain the timber effect we seek to portray, and we believe at every stage of its life Millboard truly reflects this more than any other timber alternative product, due to being moulded from real timber and the hand coloured process.

On delivery if you find the colour unacceptable or believe them to be defective in any way, please contact us. If there are any foreseen issues with the boards, this should be highlighted with Millboard before installing.

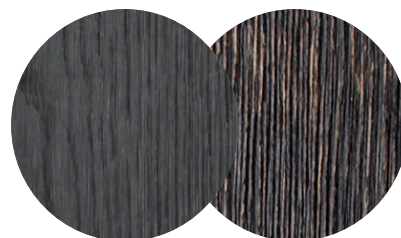
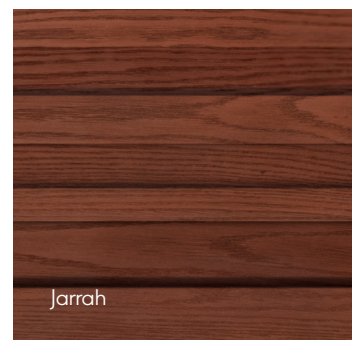
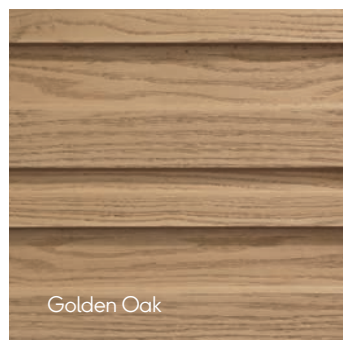
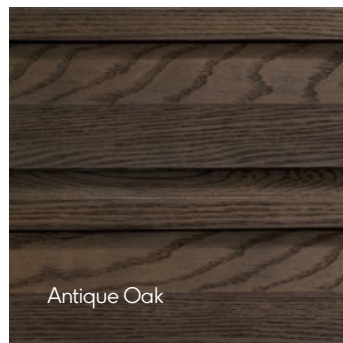
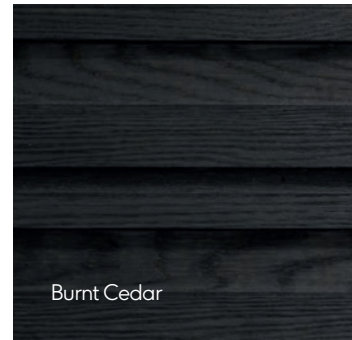

⬆ Colour tone may vary from batch to batch.
Antique Oak has more variance between boards.

Material Calculator

The area (m²) is the total wall area to be clad.

m² = width x height

(minus the area of any windows & doors)

Number of boards = m² x 1.53

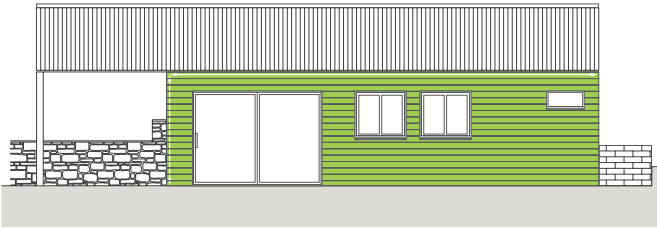

Horizontal Installation

Horizontal starter Trims = length of cladding area / 2.5



Perforated Closures will be needed at the top & bottom of the cladding and any windows, and the top of any doors.



Number of perforated closures = [(width of cladding area x 2) + (width of all windows x 2) + (width of all doors)] / 3

Corners, windows & doors

Square Corner Trims = total linear m for corners and around windows and doors / 3

Reveal boards = total linear m around windows and doors / 3.6

Extra perforated closures = Number of corner trims



Fixings

Number of boxes

30mm fixings = number of cladding boards x 10 / 250

20mm fixings = number of perforated closures + corner profiles x 14 / 250

Envello Coloured Head Screws = (number of Reveal boards x 26) + number of cladding boards / 100

Touch-up coating = 1 tin per project

Tip:

Allow extra material for wastage and offcuts. We would recommend adding at least 10% to the quantities, complex designs may require more material.

Materials

Cladding boards & accessories



Envello Board & Batten⁺ Cladding boards

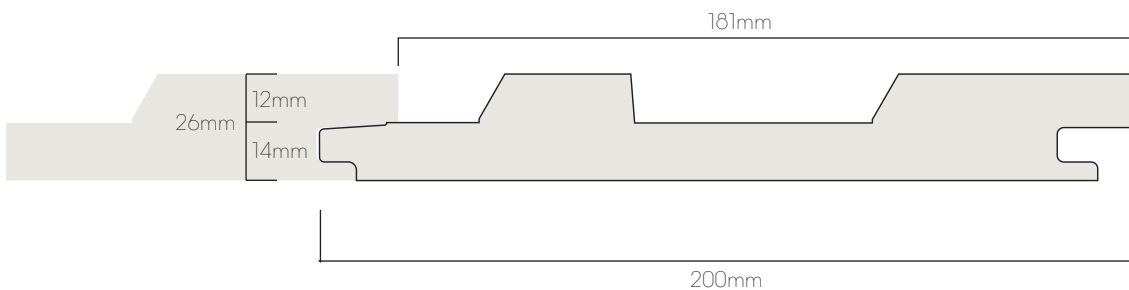

Dimensions: 200x26x3600mm

Actual 'installed width': 181mm

Boards per m²: 1.53*

Colours:	Smoked Oak - MCBF360D	Burnt Cedar - MCBF360R
	Antique Oak - MCBF360A	Limed Oak - MCBF360L
	Golden Oak - MCBF360G	Jarrah - MCBF360J

Fixings: 30mm fixings,
Coloured Head screws

*When installed

Cladding boards & accessories

Envello Square Corner Trim

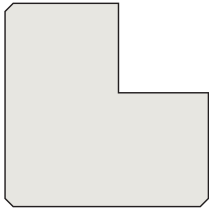

Dimensions: 50 x 50 x 3050mm
 Colours: Smoked Oak - MCPTF50D
 Antique Oak - MCPTF50A
 Golden Oak - MCPTF50G
 Burnt Cedar - MCPTF50R
 Limed Oak - MCPTF50L
 Jarrah - MCPTF50J

Fixings: Perforated closure, 20mm fixings

Profile used with the Board & Batten⁺ to finish off the external and internal corners of the building, and used around windows and doors.

Horizontal Starter Trim J



Dimensions: 25 x 10 x 2500mm
 Product code: GT250J
 Fixings: 20mm fixings

Aluminium trim used to start the cladding at the bottom, when the cladding is installed horizontally.

Millboard Reveal Boards



Dimensions: 146 x 16 x 3600mm
 Colour: Smoked Oak - MCR146D
 Antique Oak - MCR146A
 Golden Oak - MCR146G
 Burnt Cedar - MCR146R
 Limed Oak - MCR146L
 Jarrah - MCR146J

Fixings: Coloured Head screws, Brad nails

Reveal Boards may be required for window/door reveals or soffits.

Perforated Closure



Dimensions: 50 x 25 x 3000mm
 Product code: GP300L
 Fixings: 20mm fixings

Aluminium closure used to prevent insects/rodents getting into the ventilated cavity behind the boards, but allowing airflow. Fixed at the bottom of the cladding with the starter trim, also at the top on its own, as well as with the square corner trim.

Materials

Cladding Accessories Fixings



Size: 3.5 x 20mm
 Quantity: Box of 250
 Product code: FC20P250

A2 Stainless Steel fixings used to fix the corner trims, starter trims and perforated closures

Cladding Board Fixings



Size: 3.5 x 30mm
 Quantity: Box of 250
 Product code: FC30P250

A2 Stainless Steel fixings used to fix the Envello cladding boards on to the battens, fixing through the tongue of the boards

Envello Coloured Head Screws



Dimensions: 3.5 x 40mm
 Quantity: Box of 100
 Product code: Smoked Oak - FC40P100D
 Antique Oak - FC40P100A
 Golden Oak - FC40P100G
 Burnt Cedar - FC40P100R
 Limed Oak - FC40P100L
 Jarrah - FC40P100J

In most instances the cladding boards are fixed using the 30mm fixings through the tongue. Envello Coloured Head Screws may be required for fixing the cladding boards where a fixing through the tongue is not possible, also used for fixings Reveal boards.



Alternative to the Coloured Head Screws:

As an alternative to the Coloured Head screws, 16g stainless steel brads can be used through the face of the board. The brads need to be a minimum of 38mm long, the overall length will depend on the depth of the battens used.

This guide will detail how these can be used in conjunction with the cladding. A small hole may be left where the brad nail has gone through the board surface.

Touch-up Coating



Touch-up used for coating any exposed cuts or edges on the Cladding boards, corner trims or reveal boards.

Additional items that may be required (supplied by others):

- Flashing/drip profiles (around windows/doors/openings or at the bottom of the cladding)
- Fixings for installing the battens on to the structure (suitable type of fixing for the structure and battens used)
- Screws for fixing the battens together (suitable type of screw for the location and battens used)
- Clear high performance sealant adhesive (eg. CTI, Soudall Fix All)
- Polyurethane wood glue (used when mitring the boards)
- Super glue (used when mitring the boards)
- Suitable treated timber battens
- 16g Stainless Steel Brad nails (as an alternative to the coloured head screws)





Preparation

Ventilation

Ventilation for the control of moisture is a key element in the design and construction of cladding. It is a requirement not an option and should not be overlooked. A continuous airflow from bottom to top is vital for long term durability.

As a rainscreen system it assumes that the cladding will always be subject to some moisture penetration, therefore the surface that the battens will be fixed to needs to provide the waterproof finish.

Although a breather membrane is necessary for a timber frame, it may not be required on a masonry cavity wall.

Where the substrate is an existing building with solid walls (i.e. no cavity), to prevent water penetration the wall should be given a waterproof coating or a breathable membrane should be fitted.

Whatever system is used a minimum 19mm open cavity should always be provided behind the cladding and a minimum 10mm continuous gap left at the top and bottom of the system for full ventilation to dissipate any condensation or drainage at the bottom. (see fig. 1)

Consideration regarding insect and rodent invasion should also be considered and a perforated closure should be used to counter these threats where there is the required air gap, whilst still maintaining the required air flow.

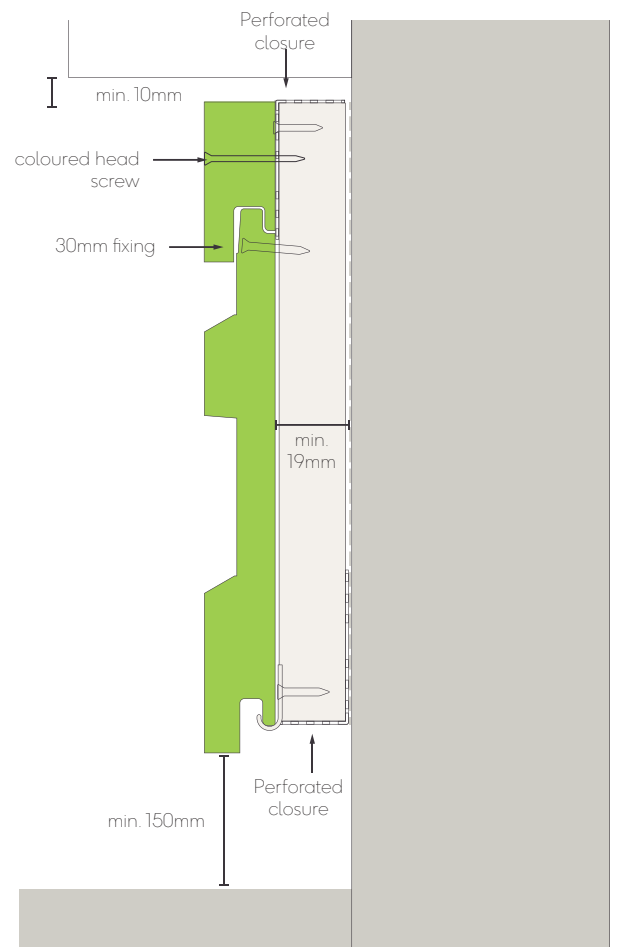

Fig.1 - Top & bottom cladding detail

Preparation

Cladding support batten

The time and care taken on setting/fixing the support system right will be reflected in the finished result. Time taken to upright corners and straighten battens on undulating walls will make the installation of the cladding a far easier installation and a superior finished result.

Suitable treated timber battens can be used as the battens for the cladding boards, we would recommend putting a strip of DPC, joist tape or EPDM on to the front of the timber battens that the boards will be attached to.

Batten size requirements:

- Main Cladding batten - minimum size of 25x50mm

The maximum support spacing is shown in table 1. For areas of high wind loading exceeding 1.0kN/m², severe weather exposure or where exceptional impact loading requirements are anticipated (i.e. low-level applications near pedestrian access, schools, leisure facilities etc.) batten support spacing should be reduced to increase the board stiffness, see chart below.

There should always be battens attached to the wall vertically to allow clear ventilation behind the boards. When the cladding is set horizontally the boards would be fixed directly to these battens at the centres shown below.

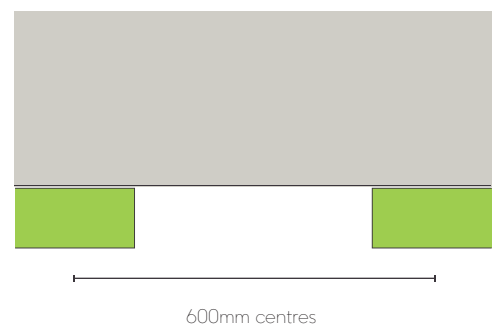

Fig. 2 - Batten centres

Table 1:

Product	Maximum Support Centres	Support Centres for high load areas
Board & Batten [†]	600mm	400mm

The batten layout around windows/doors/soffits should be that it allows the continuous airflow behind the boards, a 10mm gap should be left between the underside of the windowsills or soffits and at the head of windows/doors. (see fig. 3) The battens up the side of the window/doors should be flush with the opening: all vertical battens should be upright.

The perforated closure should be used in all areas where there is an opening to the ventilated cavity, to prevent insects entering the cavity (The perforated closures may need to be turned up at each end of the window/door sill). The Millboard Perforated closure suits batten sizes of 25 or 50mm, if battens different to these sizes are used then perforated closures or flymesh supplied by others should be used.

It is best for the perforated closure to be held between the back of the battens and the wall. This should be taken in to consideration when fixing the battens, alternatively they can be fixed to the front of the battens using the 20mm Accessories fixings.

Determine at what height the cladding is to start at. If it is starting at ground level, it should start at a minimum of 150mm above finished ground level (see fig. 4), or at least 10mm from decking/free-draining surface (see fig. 5). With a laser line or level, mark up a level line around the building or along the wall that is to be clad. This line will be the bottom of the batten/s.

Battens should be fixed to the structural wall using suitable external grade fixings, for fixing to a timber frame the battens should preferably be fixed into the timber studs of the frame. The battens should be fixed upright, packers may be needed for these if the wall is undulating.

We would recommend the use of fire ventilated cavity barriers where there are opening into the cavity behind the cladding, including at the bottom and tops of windows & doors.

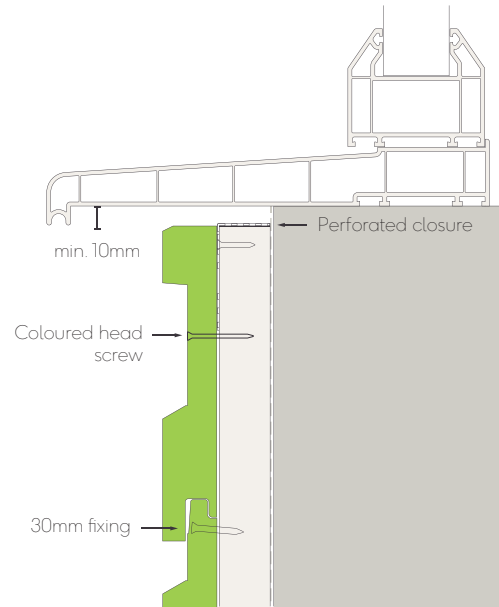

Fig. 3 - Window/door sill detail

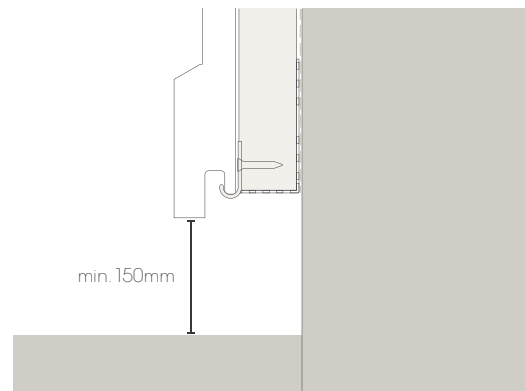

Fig. 4 - Install detail above ground level

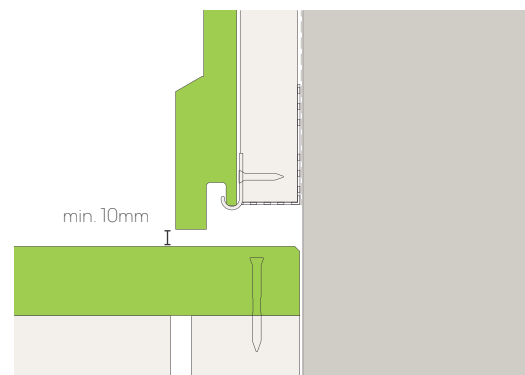

Fig. 5 - Install detail above deck

Installation

Before starting to install the main cladding area, it is important to take into consideration how the corners will be detailed (corners of the building and also corners of openings - windows/doors).

Corners of the building

For the external and internal corners of a building it can be done in two ways: Utilising the Envello Square Corner Trim or mitring and gluing the boards. With the Envello Square Corner Trim, this should be fitted before all of the Starter Trims or Board & Batten+ boards are fitted.

For internal corners using the Square Corner Trim, two perforated closures are fixed to the back of the square corner trim using the 20mm accessories fixings, these are then fixed to battens in the corner. This is shown in fig. 7

For external corners using the Square Corner Trim, the perforated closure is fitted to the back of the Corner Trim using the 20mm Accessories fixings at 200mm centres, these are then fixed to the battens on the corner. Shown in fig. 6 & 8

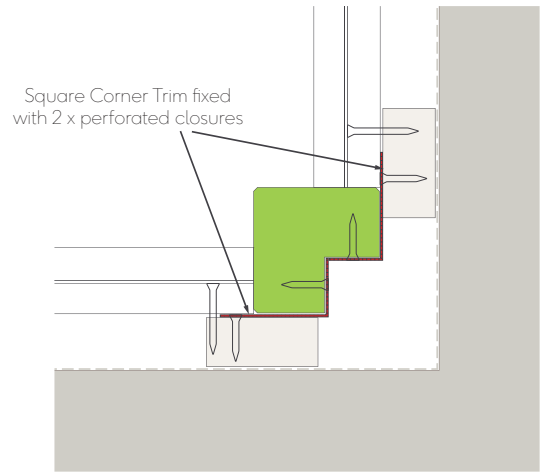

Fig. 7 - Internal corner detail

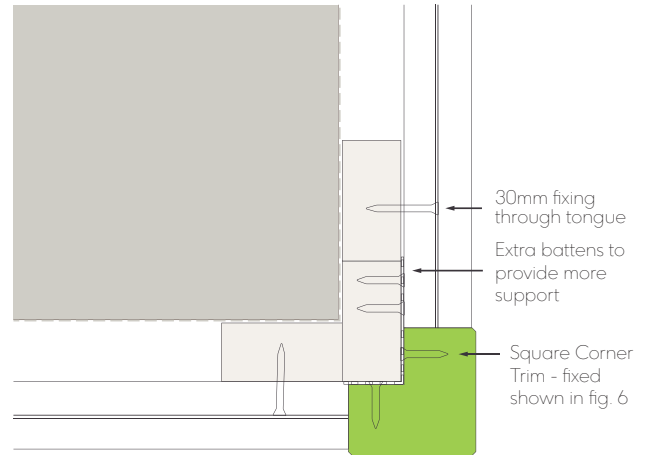

Fig. 8 - External corner detail

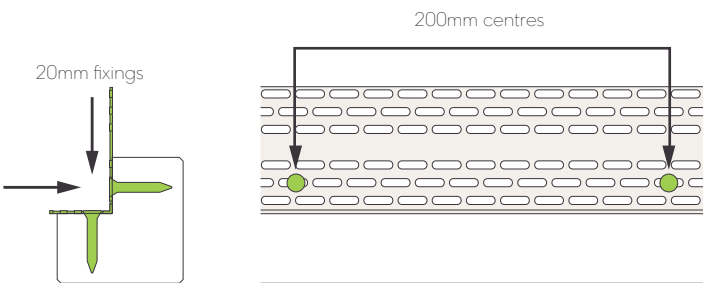
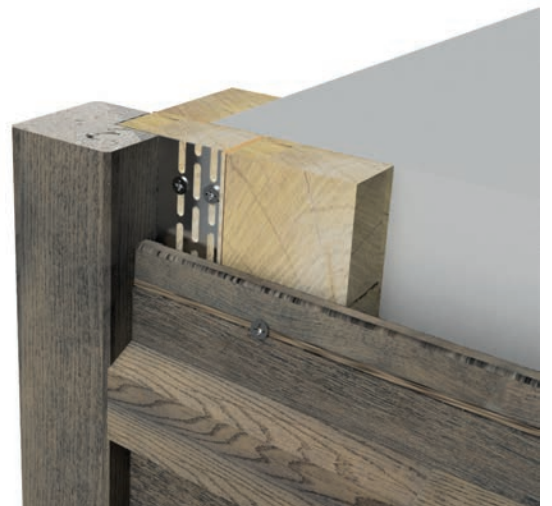

Fig. 6 - Use of perforated closure on square corner trims



Alternatively, the boards can be mitred to finish off the corner, this would also be applicable if the corner is anything other than 90 degrees.

It is best to use the same board around the corner so that the wood grain pattern, colour tone, and profile match. Ensure to stagger the end joints of the boards ie. $\frac{1}{2}$ to $\frac{1}{2}$

When mitring the boards on a corner, this is done at the same time as installing the cladding boards. These mitred joint details can be seen in fig. 9 & 10

Tip for mitre joints:

Mitre and dry fit the boards to make sure the joint fits well. apply polyurethane wood glue to the core of the boards and superglue to the surface layer.

Bring the joint together with the front edge touching together first, then close the back of the joint and drop into place. If any PU glue bubbles out of the joint, wait until it is semi-dry and remove. Touch-up Coating can be used on any small imperfections on this joint.

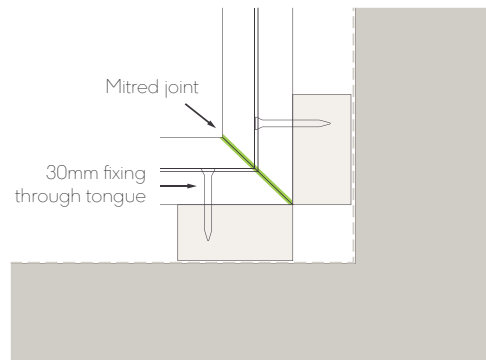

Fig. 9 - Internal mitred corner detail

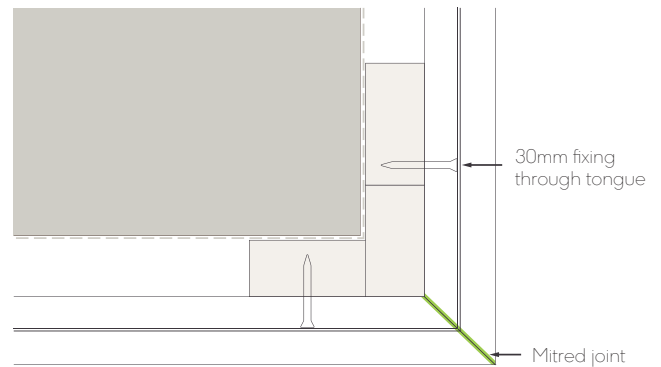
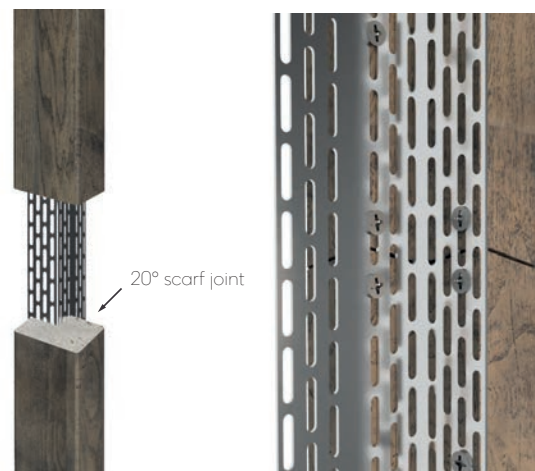

Fig. 10 - External mitred corner detail

Joining Square Corner Trims

When joining two Corner Trims together to make a longer length, these should be joined on a 20° scarf joint. Dry fit the profiles first to make sure they align, the profiles should then be bonded together using superglue, once bonded press together to ensure the faces line through. Once the adhesive is set, they should be joined so that the perforated closure connects both profiles together.



Details around windows & doors

Around an opening such as a window or door, the Envello Square Corner trim can be used, this would again be fixed to the perforated closure first before being fitted to the battens. Again, the perforated closure is fitted to the back of the Square Corner Trim using the 20mm Accessories fixings at 200mm centres, these are then fixed to the battens around the opening. The mitres of the Square Corner Trims can be bonded together using superglue.

Reveal boards are used to line the inside of the reveals, either fixed to the timber battens/framework or bonded to the masonry using a clear polymer adhesive (please note the back of the reveal board will need to be sanded before being bonded to masonry, to give the adhesive a key to hold the reveal board).

Please ensure that all all windows and doors are sealed sufficiently before installing cladding around them, ensure that the cladding detailing doesn't have a detrimental impact on the performance of the windows/door.

We'd recommend putting a clear polymer Adhesive/ sealant behind the Reveal or cladding boards that are used around the opening before fixing in place.

Another alternative way to finish off around window/ door heads is to cut the boards on an 20 degrees angled cut and coat the cut with touch-up. again the reveal board would be used to line the reveals, shown in fig. 13

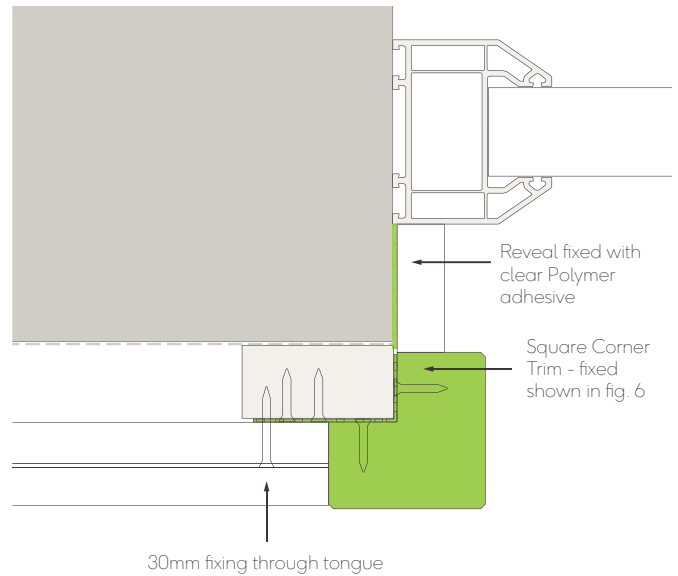

Fig. 11 - Window/door jamb with corner trim

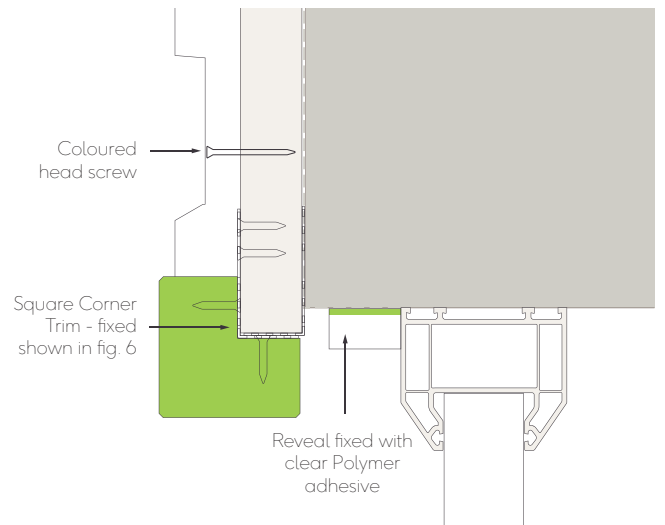

Fig. 12 - Window/door head with corner trim

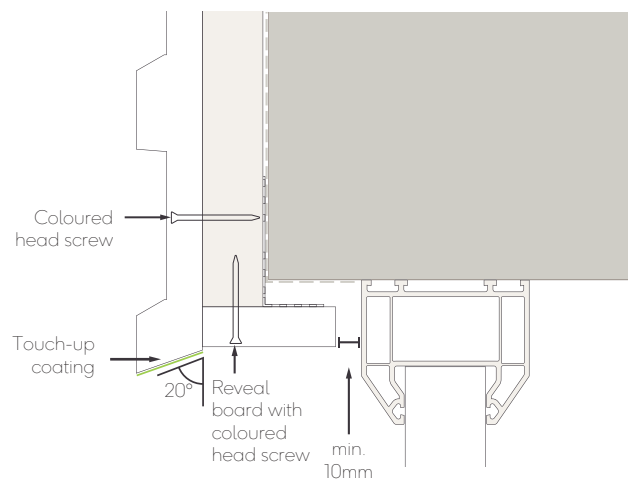

Fig. 13 - Window/door head with angled cut

Alternatively, the reveal boards can be used around the full depth of the reveal with no Square Corner trims. As the back of the reveal boards is on show in this way they would need to be sanded and coated in touch-up coating before being installed, shown in fig. 14 & 15.

When using alternative methods of detailing the window/door heads/jambes other than the Square Corner Trim, this is done at the same time as installing the cladding boards.

Any detailing around an opening should allow for airflow to get in to the cavity above the opening.

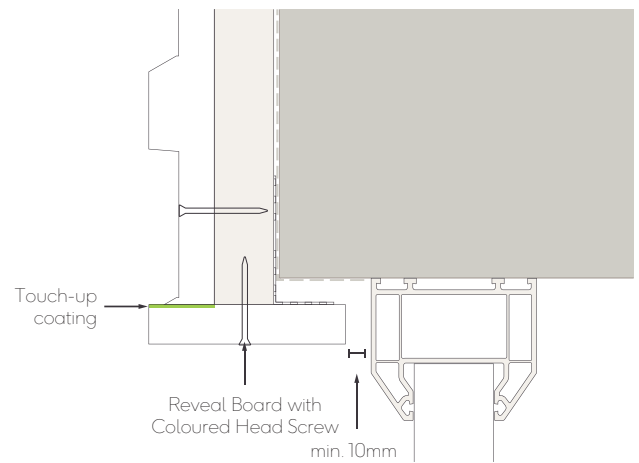

Fig. 14 - Window/door head with reveal boards

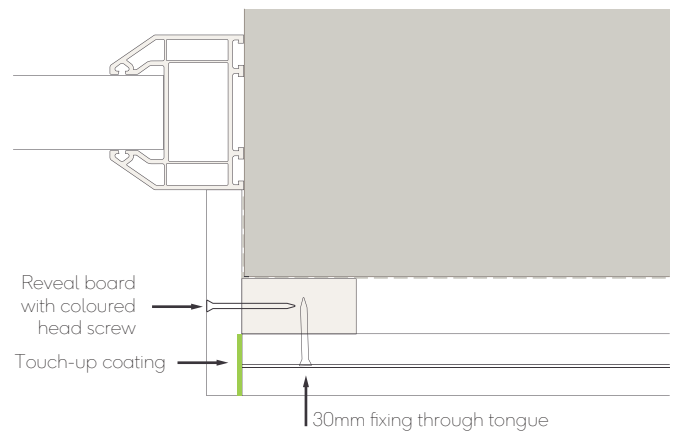

Fig. 15 - Window/door jamb with reveal boards

When using brads to fix Cladding and reveal boards around window/door openings, we would recommend the use of a clear polymer adhesive/sealant to help secure the products in place.

If brad nails are being used through the board face as an alternative to the Coloured Head screws, there needs to be two brads per batten intersection if the cut-down board is more than 50mm wide and the brads put in at angles. Example shown in fig. 16. Please note that brads can only be used as an alternative to the coloured head screws and should not be used through the board tongue instead of the 30mm cladding board fixings. A small hole may be left where the brad nail has gone through the board surface.

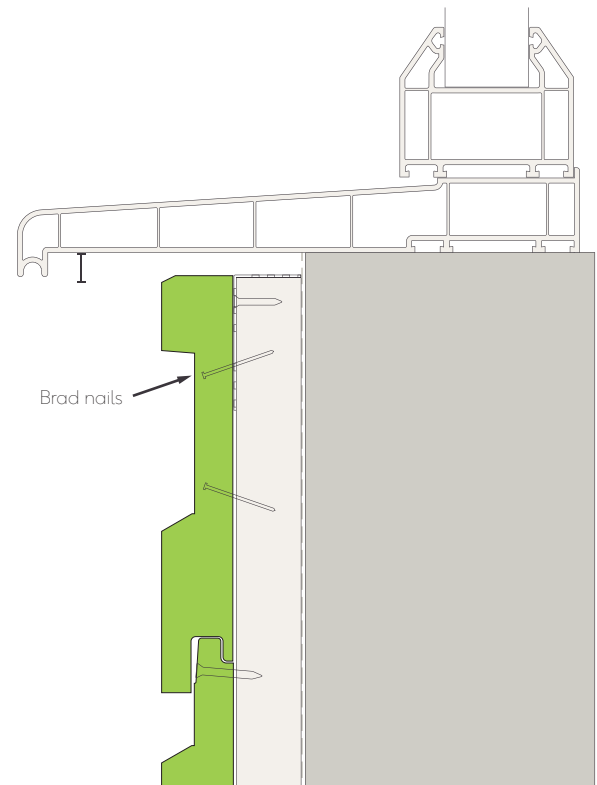

Fig. 16 - Window/door sill junction detail - brad nails

Installing Starter Trims

The Starter trims should be fitted at the bottom of the battens.

It is important that these trims are installed level so that the boards running off these trims are level.

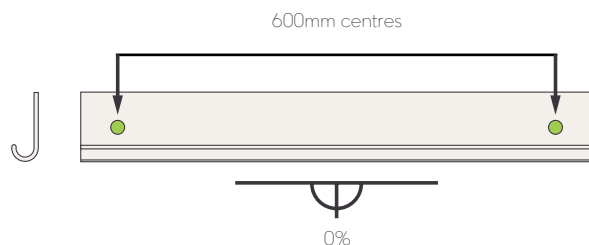

Fig. 17a - Starter trim install

These starter trims are fixed to the battens using the 20mm Accessories fixings with the heads countersunk into the trim.

The bottom edge of the board is lower than the bottom of the Starter trim, please bear this in mind when setting the height of the starter trim.

Fixings

The Board & Batten⁺ boards should be fixed through the tongue with the 3.5x30mm cladding screws, with one fixing per batten intersection and two per batten when joining boards.

The fixings should be inserted through the fixing guide groove on the tongue and angled in slightly, the head should sit flush with the surface.

The fixings do not need to be predrilled or countersunk, the boards will allow the head to countersink slightly.

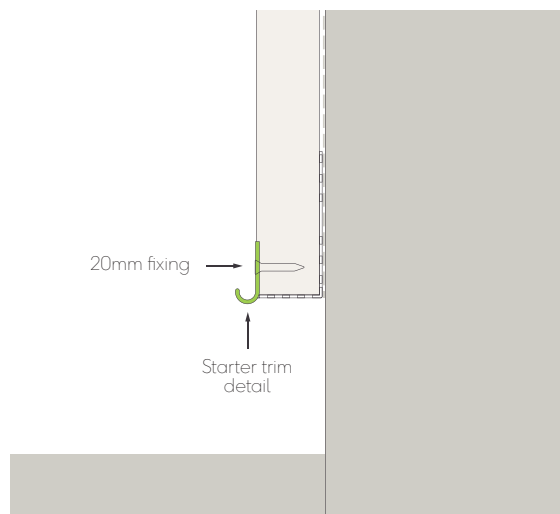

Fig. 17b - Starter trim detail

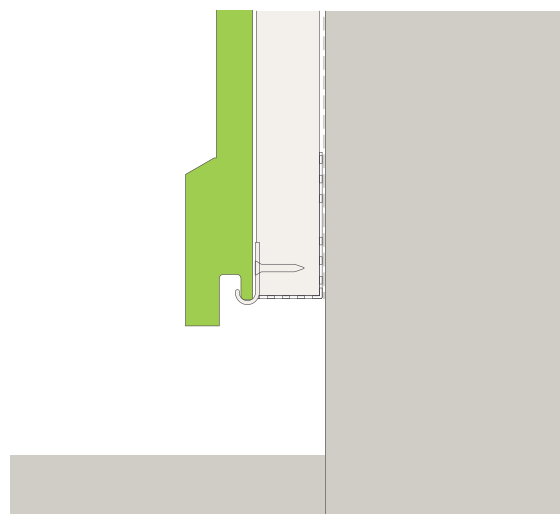

Fig. 18 - First board install



Once the first row of boards have been installed, the second row of boards can be installed on top of it, with the groove covering the tongue of the previous board. Check the boards against a level every 4/5th board to ensure that the boards are keeping level. adjust the spacing between the following boards accordingly if needed.

When the tongue is taken off the boards to fit around windows/doors, or up to the soffit, 40mm Coloured Head screws or brad nails will need to be used through the board face. Shown in fig. 12-16

Joining boards

When joining boards end-to-end, this should be done where there is a batten behind, so both ends are supported by a batten. It is best to not have the joints all in one line, so that they are spread out across the cladding area.

As the boards are manufactured through a moulding process we recommend that all ends are cut before they're installed. Dry fit the boards first to make sure they align, using boards that are of appropriate dimensions to ensure a consistent finish.

We recommend that the boards are joined with a 20 degree scarf joint with one overlapping the other, the front face of the cut should be painted in Touch-up Coating.

As Millboard is made from a resin mineral composition it is stable in comparison to timber or composites based on timber, the amount of movement that is acceptable is up to 0.2%.

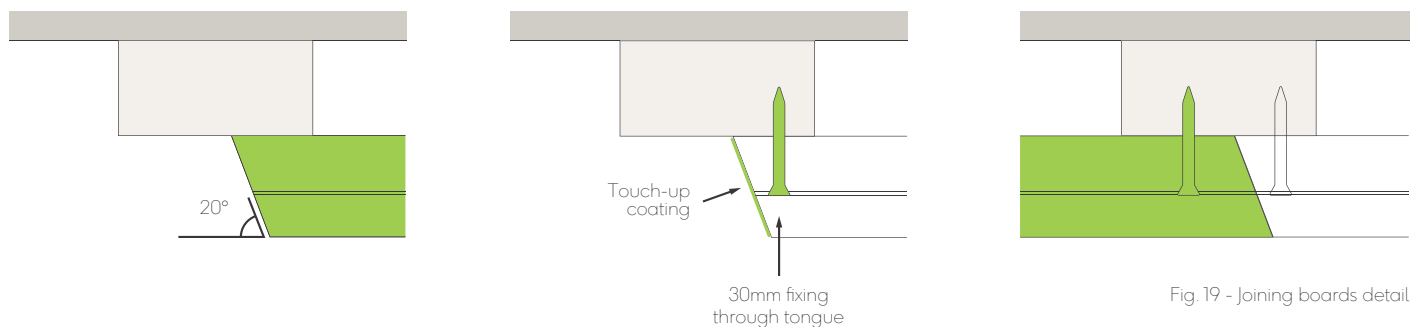
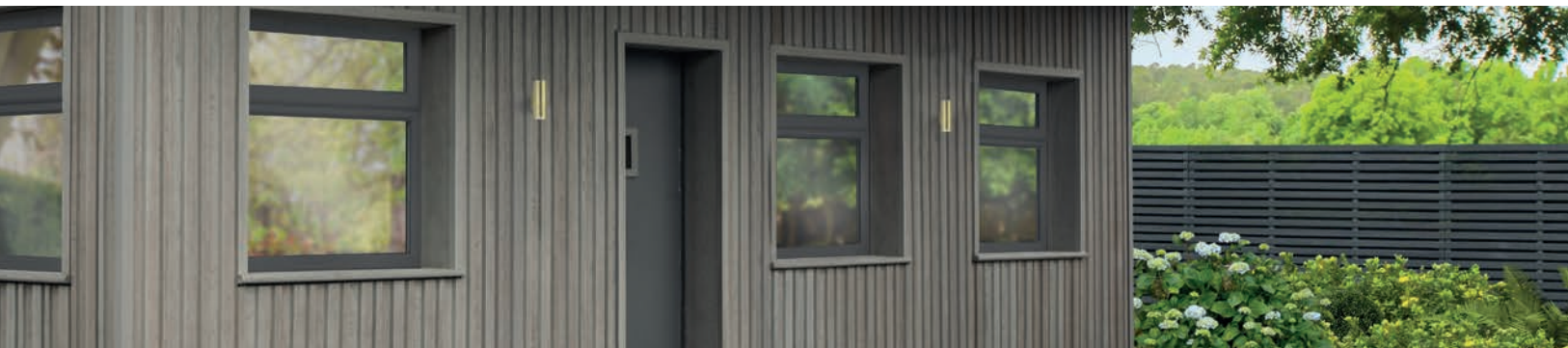

Fig. 19 - Joining boards detail



Installation Abutting Render

The junction between Envello and render can be done in a number of different ways, however we'd recommend doing the rendering first before fitting the cladding boards and finishing the render up to a render stop bead rather than directly up to the cladding.

Please ensure that you leave a 3-4mm gap between the render stop and the edge of the cladding/corner trims.

When running the Board & Batten⁺ boards up to render on a wall, the Square Corner Trim can be used as shown in fig. 20

The junction between the Board & Batten⁺ boards and render on a corner can be done utilising the Envello Square Corner Trim, this is shown in fig. 21

When installing cladding above render, it is best to install a flashing detail which goes up behind the cladding battens and protrudes further than the render. This is to allow rain water to drip off the flashing detail, this can be seen in fig. 22

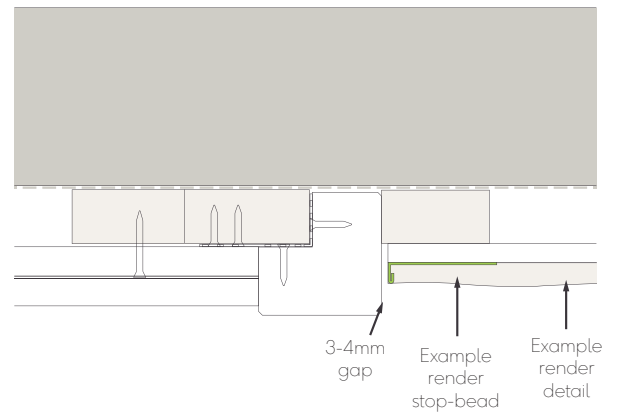

Fig. 20 - Corner profile butting up to render

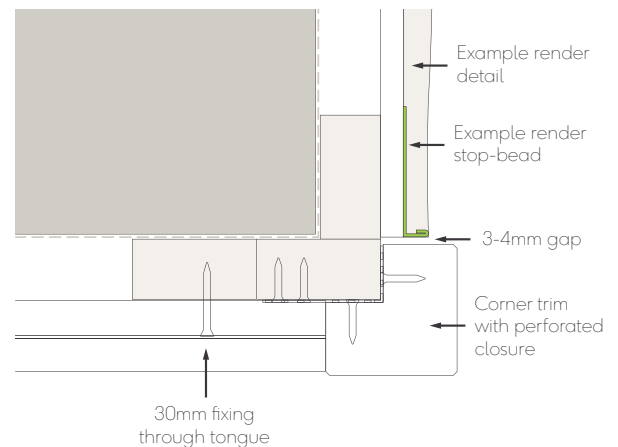

Fig. 21 - Corner profile butting up to render on external corner

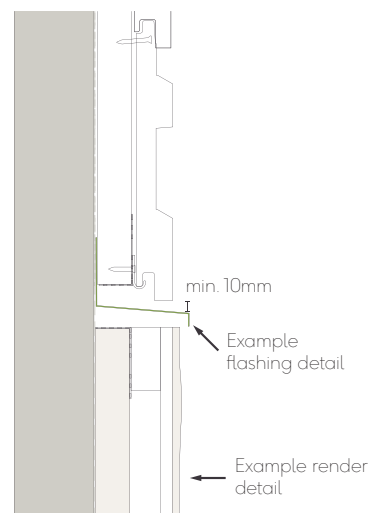

Fig. 22 - Installing cladding above render

After care

Cleaning

If the boards become dirty during installation, they should be cleaned as soon as possible using warm soapy water and a brush or pressure washer.

We recommend that the cladding is cleaned once to twice a year to remove surface dirt and debris.

Start cleaning at the top of the cladding and work downwards along the grain. It is best to use a brush with an extendable handle to clean the boards.

Pressure washers can be used on Envello Cladding, with a PSI of no greater than 2000. A fan tip should be used with a 40 to 60 degree spread, keeping the head 250-300mm away from the surface. Test in an inconspicuous area first - direct, prolonged contact could damage the surface of the boards.

Take extra care when using a pressure washer around windows, doors and cut ends of boards.

Stubborn marks may be removed with a range of different cleaners depending on the mark.

If you have any queries or concerns regarding your Millboard cladding, please email us at technical@millboard.co.uk, or call our UK support team on 024 7643 9943.



Live. Life. Outside.



The Millboard Company Ltd
UK Head Office
Unit A, Castle Court
Bodmin Road
Coventry CV2 5DB

T: +44 (0) 24 7643 9943
E: enquiries@millboard.co.uk

millboard.co.uk



Company registered No. 06061318
VAT No: 980 616602

© 2023 The Millboard Company Ltd. Millboard®, Lastane®, Durafix®, Lasta-Grip®, DuoSpan®, Envello® and the phrase "Live. Life. Outside.™" are protected trademarks. Patents and Patents Pending apply to Millboard® products. The company will vigorously defend its patent rights. Due to printing restraints, actual colours may vary from those shown in brochure. This brochure is not to be reproduced or copied without written permission from Millboard directors. Millboard has a policy of continual improvement to specification. Product blend, colours and sizes may change without notice. All sizes and measurements are nominal. Information is correct at time of going to press. Patent numbers include GB 2445714, GB 2449184, USA 8,065,849, CAN 2664329, EU 1951971.