



millboard

Live. Life. Outside.

—
The Millboard
Collection





The finest outdoors

millboard



Contents

About Millboard	The Millboard story	6
	A closer look	8
	Why choose Millboard decking?	9
Enhanced Grain	The Collection	10
	Case Studies	28
Weathered Oak	The Collection	36
	Case Studies	44
Lasta-Grip	The Collection	52
Edging & Fascia	The Collection	56
	Colour options	59
DuoSpan & DuoLift	The Collection	60
	About DuoSpan and DuoLift	62
Components & Materials	The Collection	70
	Plas-Pro	72
	Touch-up Coating	74
	Durafix®	75
Useful Information	Working specification	76
	A focus on sustainability	78
	Maintenance	79
	Alternative Uses	80
	Samples, Ordering and Installation	82



22



32



38

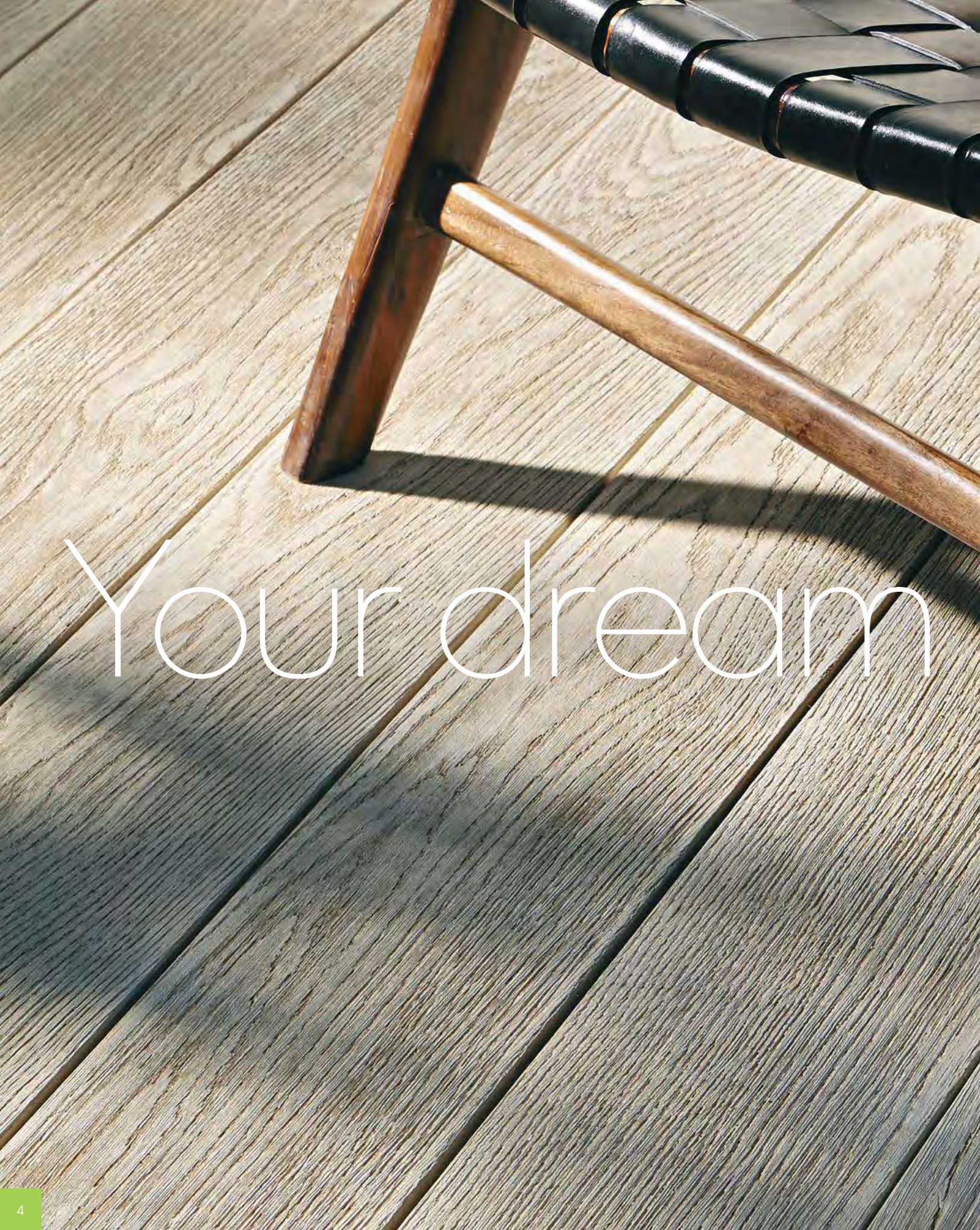

Your dream



deck awaits

The Millboard story

Enduring beauty

A family-run business, the company has been marrying British craftsmanship to the inspiration of nature since 1976. Millboard decking demonstrates the company's commitment to quality and visual distinction.

1976

Millboard founding family starts Stonemarket, which revolutionises cast paving – later sold to a large group entity.

1998

After the sale of Stonemarket, attention turns to production of stone-look planters and other innovative outdoor products.

2007

After four years of ground-breaking development, Millboard wood-look moulded decking is launched to the UK market.

2014

Millboard is voted one of the top 1000 companies in the UK to inspire Britain – a major achievement in just seven years.

The only decking hand-moulded from natural timbers, Millboard decking is virtually indistinguishable from real wood, yet outperforms it on almost every level. Unlike timber boards, or even some conventional composite boards, Millboard decking resists the elements, requires minimal maintenance, is slip and stain resistant and won't rot from fungal decay or warp, unlike timber.

The mould masters for the Millboard range are carefully selected. The Weathered Oak range, for example, is moulded from over a century old oak boards. And the Enhanced Grain range is exquisitely rendered from refined timber for a smooth look and feel.

Each board is carefully hand-coloured in the realistic true-to-life tonal shades that are Millboard's signature feature. This attention to detail reflects Millboard's desire to provide the most authentic wood-look decking on the market today.

Our ethos is to continually reinvest in new product research and development. This has led us to bring some of the most advanced and unique products to the market - our patented Durafix® screws and Lastane® coated board are just two of our exclusive innovations.

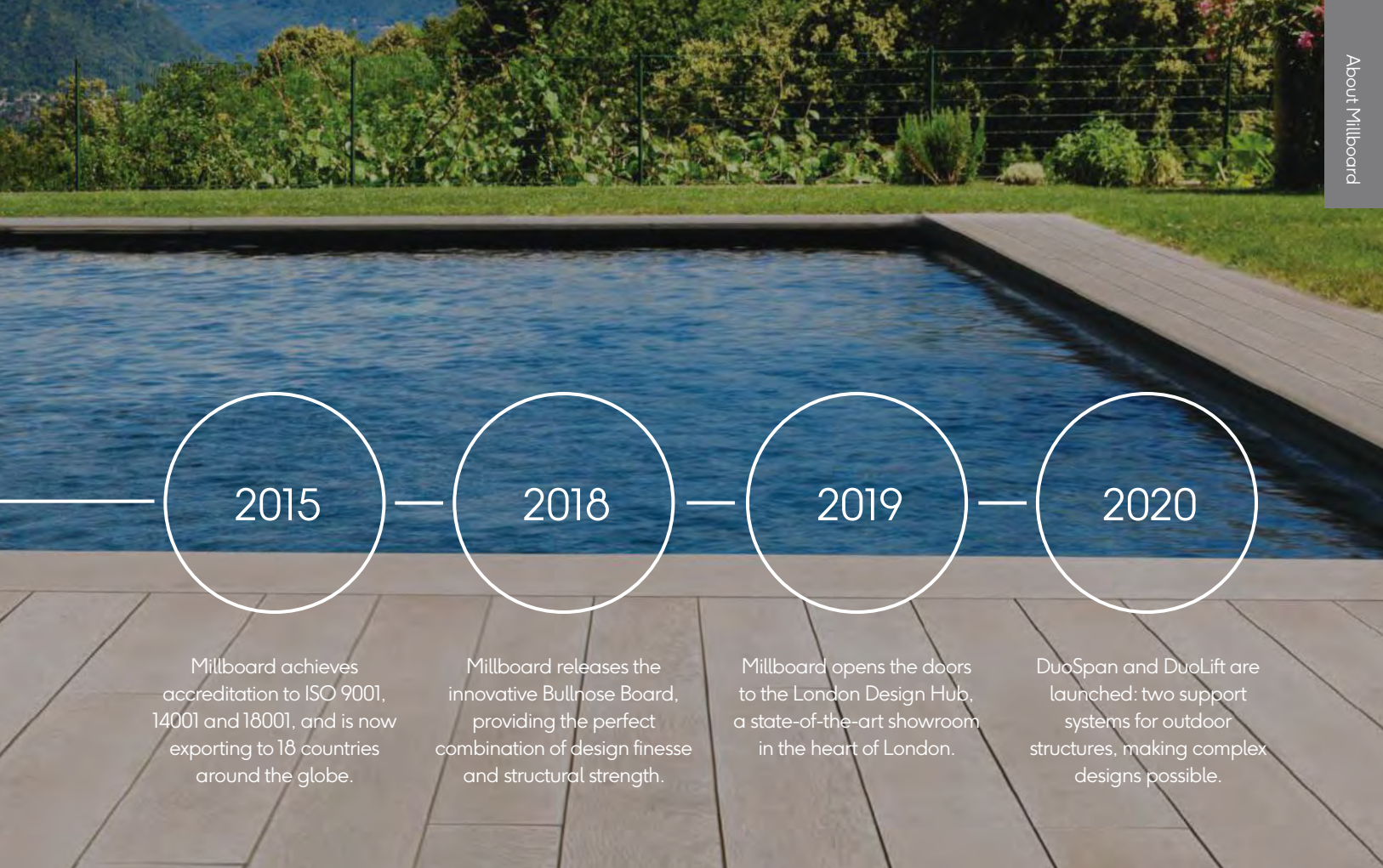

2015

Millboard achieves accreditation to ISO 9001, 14001 and 18001, and is now exporting to 18 countries around the globe.

2018

Millboard releases the innovative Bullnose Board, providing the perfect combination of design finesse and structural strength.

2019

Millboard opens the doors to the London Design Hub, a state-of-the-art showroom in the heart of London.

2020

DuoSpan and DuoLift are launched: two support systems for outdoor structures, making complex designs possible.



About Millboard decking



A closer look

Millboard decking uses a unique material, unrivalled across the globe. Take a closer look at the construction and performance of this stunning yet functional decking.

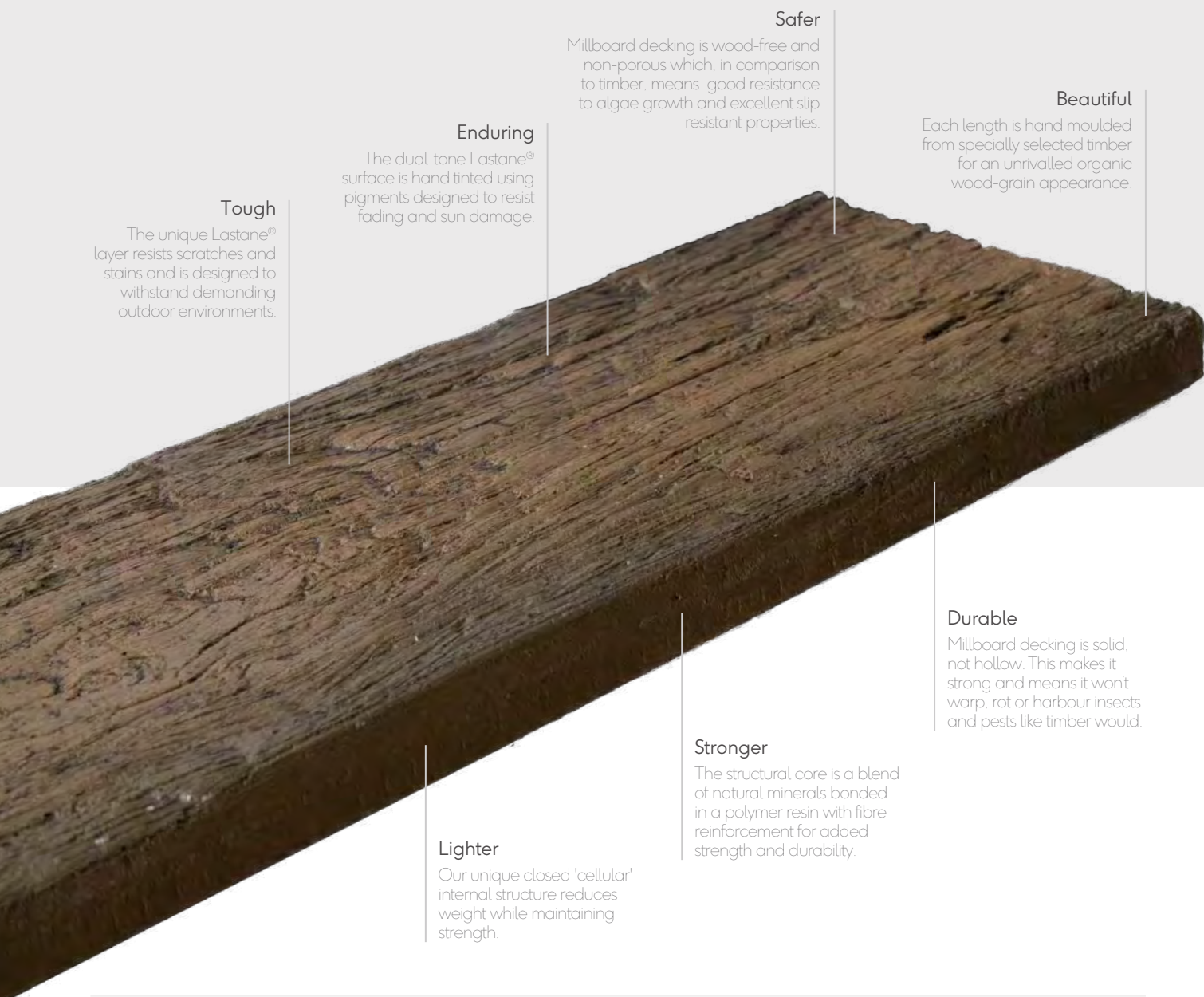

Tough

The unique Lastane® layer resists scratches and stains and is designed to withstand demanding outdoor environments.

Enduring

The dual-tone Lastane® surface is hand tinted using pigments designed to resist fading and sun damage.

Safer

Millboard decking is wood-free and non-porous which, in comparison to timber, means good resistance to algae growth and excellent slip resistant properties.

Beautiful

Each length is hand moulded from specially selected timber for an unrivalled organic wood-grain appearance.

Durable

Millboard decking is solid, not hollow. This makes it strong and means it won't warp, rot or harbour insects and pests like timber would.

Stronger

The structural core is a blend of natural minerals bonded in a polymer resin with fibre reinforcement for added strength and durability.

Lighter

Our unique closed 'cellular' internal structure reduces weight while maintaining strength.

Millboard decking combines the natural beauty of real wood with the high performance of a hybrid of polyurethane, a material widely recognised for its unique properties. Polyurethane is used in many industries where durability and strength is required, eliminating the inevitable rotting, warping and deterioration of natural wood.

Millboard decking has a unique Lastane® surface which is produced using the same pliable material as the soles of shoes, boasting slip-resistance even in wet conditions. Beneath the Lastane® surface is a polymer resin core, reinforced with fibre for extra strength and material stability, making Millboard one of the most dependable decking materials available.

Crafted to perfection

Each length of Millboard is the result of a long process of craftsmanship and attention to detail.

From the initial laying of the unique Lastane® surface, right through to the pouring of fibre-reinforced resin-mineral filler, we focus on achieving the finest quality of finish. Our respect for accuracy permeates every square millimetre and this is why many of our processes are carried out manually. For example, each piece is hand-coloured to establish an authentic wood finish.

We have great respect for the skilled eye of an artist and are therefore committed to the hand-colouring system. The resulting true-to-life shades speak for themselves.

Every step of your decking's journey is characterised by Millboard's artisan methods.



Why choose Millboard decking?



Resistant to algae

Unlike wood, there is no protein content to assist algal growth within the boards.



Slip-resistant

High grip surface much safer than wood, especially in the wet.



Moulded from real oak

Not extruded like most composites. Millboard decking looks just like the real thing.



Environmentally friendly

Base materials have low impact on global warming and ozone depletion.



Lightweight

Easier to handle and install.



Splinter-free

No wood content means absolutely no splinters.



Hygienic

It's non porous surface is easy to clean for spills and deposits.



Low maintenance

Resists stains from food or drinks spills and algae growth.



Does not warp or rot like wood

No timber content that will rot or be eaten by insects and pests.



UV and weathering stability

Millboard decking has been tested in most weathers and temperatures.



'Lost head' fixing

Durafix® fixings are virtually hidden beneath the unique Lastane® surface.



Low carbon footprint

Independently and UKAS accredited to the ISO 14064-1 Verified Carbon Footprint Assurance Mark.



The Collection:

Enhanced Grain

Exquisitely replicating every detail you'd expect from real wood

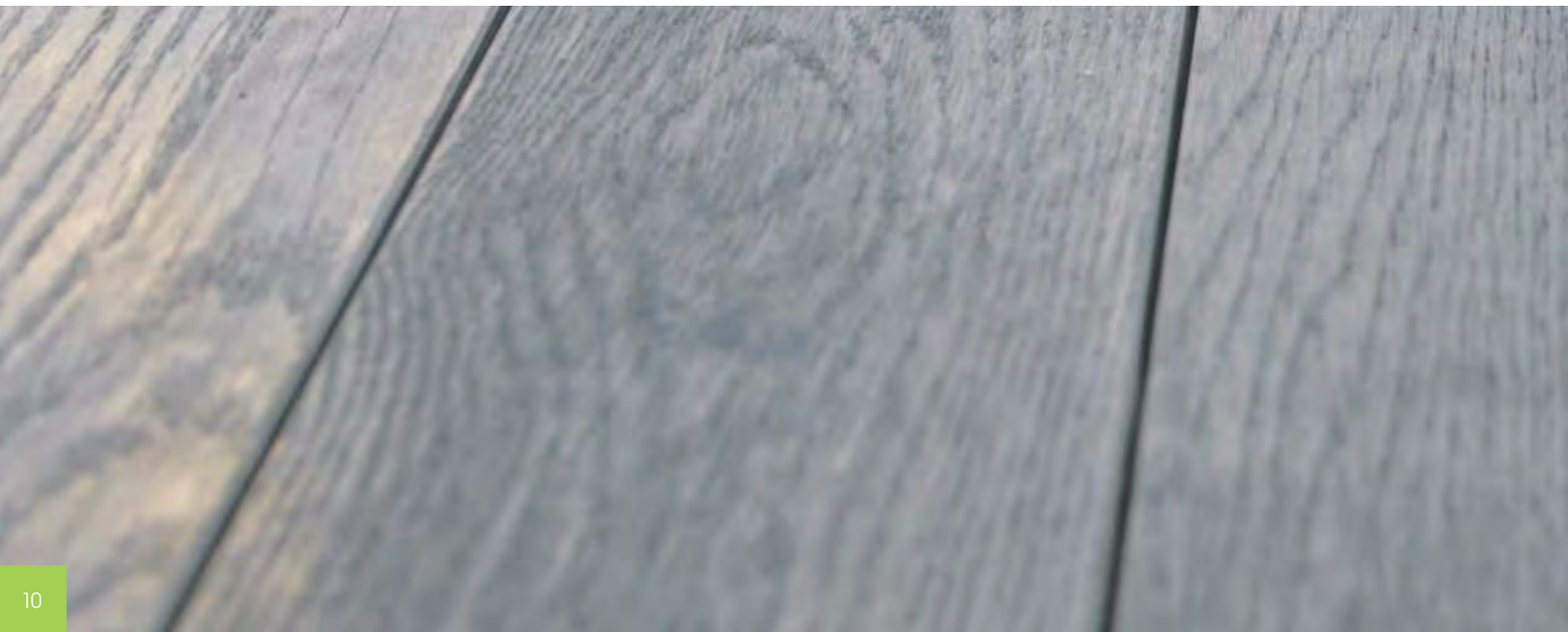

Smooth, sleek texture

Moulded from selected oak boards for a textured look and feel, the Enhanced Grain collection's contemporary design accurately recreates the subtle nuances of natural wood. Each of the shades are slip-resistant and showcase their organic patinas beautifully.

176 x 3600 x 32mm
1.54 boards per m²



Enhanced Grain

Antique Oak

Antique Oak's natural, warm hues are similar to the tones of tropical hardwood and the appearance is reminiscent of attractively aged flooring.

Antique Oak boasts more tonal variation per individual board than any of the other colours in the Millboard range, providing a beautiful and organic look.

Board size	176 x 3600 x 32mm
Coverage	1.54 boards per m ²
Product code	MDE176A



Subframe
See page 60



Alternative uses
See page 80



Product samples
See page 82



Discover more about Antique Oak:
millboard.co.uk/antique-oak

Find an Approved Installer or Premier Distributor:
millboard.co.uk/locator



Enhanced Grain Smoked Oak

A cool, elegant grey, ideal for contemporary and coastal settings. Smoked Oak has a soft-grey hue and browner tones that nod to time-seasoned hardwoods – yours to enjoy without the wait.

Its silvery decadence is at once contemporary and traditional. Smoked Oak tastefully distinguishes any outdoor space.

Board size	176 x 3600 x 32mm
Coverage	1.54 boards per m ²
Product code	MDE176D



Subframe
See page 60



Alternative uses
See page 80



Product samples
See page 82



Discover more about Smoked Oak:
millboard.co.uk/smoked-oak

Find an Approved Installer or Premier Distributor:
millboard.co.uk/locator

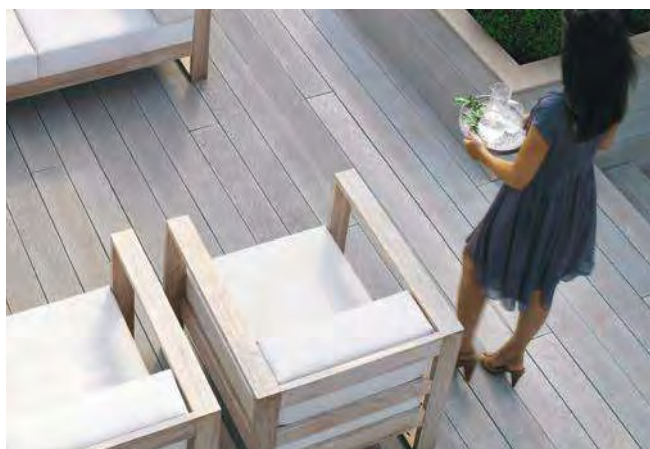

Enhanced Grain Brushed Basalt

Brushed Basalt is the most authentic painted-wood-look decking board available. This recent addition to the Millboard collection is perfect for seamless transitions between indoor and outdoor spaces.

Consciously styled to harmonise with interiors, Brushed Basalt's glamorous blue-grey hues are hypnotic and interplay beautifully with other cool and contemporary tones.

Board size	176 x 3600 x 32mm
Coverage	1.54 boards per m ²
Product code	MDE176B



Subframe
See page 60



Alternative uses
See page 80



Product samples
See page 82

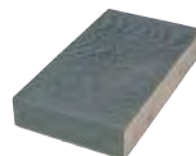

Discover more about Brushed Basalt:
millboard.co.uk/brushed-basalt

Find an Approved Installer or Premier Distributor:
millboard.co.uk/locator



Enhanced Grain Limed Oak

The look of beautifully sun-drenched timber. Limed Oak has a pale, washed appearance which is the perfect complement to outdoor spaces in sunnier climes.

Limed Oak provides a clean and dreamy aesthetic. Its cool and sophisticated presence allows you to create a refined terrace arrangement, whatever the brief.

Board size	176 x 3600 x 32mm
Coverage	1.54 boards per m ²
Product code	MDE176L



Subframe
See page 60



Alternative uses
See page 80



Product samples
See page 82



Discover more about Limed Oak:
millboard.co.uk/limed-oak

Find an Approved Installer or Premier Distributor:
millboard.co.uk/locator

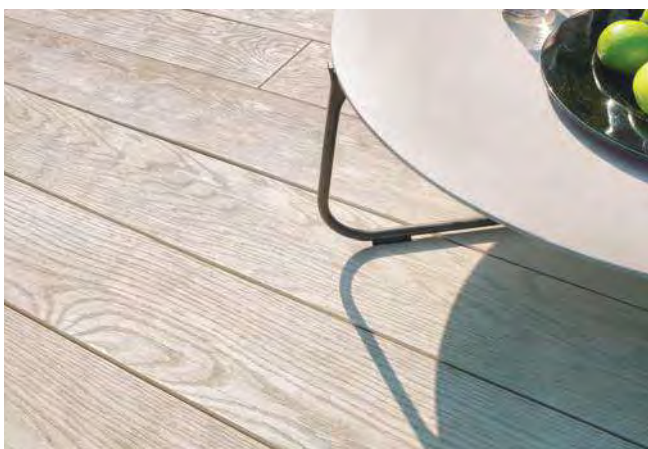

Enhanced Grain

Burnt Cedar

A dramatic statement in smooth black/brown, inspired by the Japanese Yakisugi technique of burning timber to preserve it. Burnt Cedar is the perfect mix of modern and traditional styles.

With warm undertones, Burnt Cedar is a bold showstopper and demonstrates both elegance and decadence in equal measure.

Board size	176 x 3600 x 32mm
Coverage	1.54 boards per m ²
Product code	MDE176R



Subframe
See page 60



Alternative uses
See page 80



Product samples
See page 82

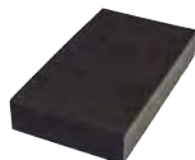

Discover more about Burnt Cedar:
millboard.co.uk/burnt-cedar

Find an Approved Installer or Premier Distributor:
millboard.co.uk/locator



"These boards gave us exactly what we wanted, and they are practically maintenance-free too."

Charlotte Homeowner



Enhanced Grain Golden Oak

An enduring, versatile classic, Golden Oak offers the appealing look of newly sawn, natural oak timber, with a light golden hue that retains its stylish appearance over time.

Golden Oak's warm tones serve as the perfect backdrop to many different tastes and preferences. Add distinction with this handsome and pleasingly traditional board.

Board size	176 x 3600 x 32mm
Coverage	1.54 boards per m ²
Product code	MDE176G



Subframe
See page 60



Alternative uses
See page 80



Product samples
See page 82



Discover more about Golden Oak:
millboard.co.uk/golden-oak

Find an Approved Installer or Premier Distributor:
millboard.co.uk/locator



"The handsome Golden Oak style offset our New England design perfectly."

Cathy Homeowner



Enhanced Grain Coppered Oak

An autumnal rich finish with a profound depth of colour, Coppered Oak creates a look reminiscent of high-quality hardwoods such as ipe or teak.

Imbue your relaxing outdoor space with the natural vibrance, texture and tone of this russet-brown shade, moulded from smooth, organic timbers.

Board size	176 x 3600 x 32mm
Coverage	1.54 boards per m ²
Product code	MDE176C



Subframe
See page 60



Alternative uses
See page 80



Product samples
See page 82



Discover more about Coppered Oak:
millboard.co.uk/coppered-oak

Find an Approved Installer or Premier Distributor:
millboard.co.uk/locator



Enhanced Grain Jarrah

A deep, burnt-sienna hue inspired by the timber of the native Australian Eucalyptus tree, Jarrah has warm, earthy tones that feel at home in a variety of situations.

Bring an exotic sense of luxury to your outdoor space with Jarrah. With its smooth visage and tropical colouration, Jarrah calls to mind remote sun-drenched islands, rainforests and retreats.

Board size	176 x 3600 x 32mm
Coverage	1.54 boards per m ²
Product code	MDE176J



Subframe
See page 60



Alternative uses
See page 80



Product samples
See page 82



Discover more about Jarrah:
millboard.co.uk/jarrah

Find an Approved Installer or Premier Distributor:
millboard.co.uk/locator



"Amazing product - so much better than my Merbau and it looks so real! Great products and good family business principles."

Paige Homeowner



RESIDENTIAL CASE STUDY

Brentwood House, Essex

The owners of Brentwood House in Essex wanted to update their brick and paving slab terrace. The existing arrangement was difficult to keep clean and patches of algae made it dangerous, especially during the winter. A local firm was brought in to redesign the space, with a brief to extend the terrace and to create a stylish, contemporary look.

Brentwood House's stunning new terrace includes an expansive space for entertaining friends and family. The built-in seating is flanked by a glass balustrade and atmospheric lighting, achieving a practical and attractive end-result.

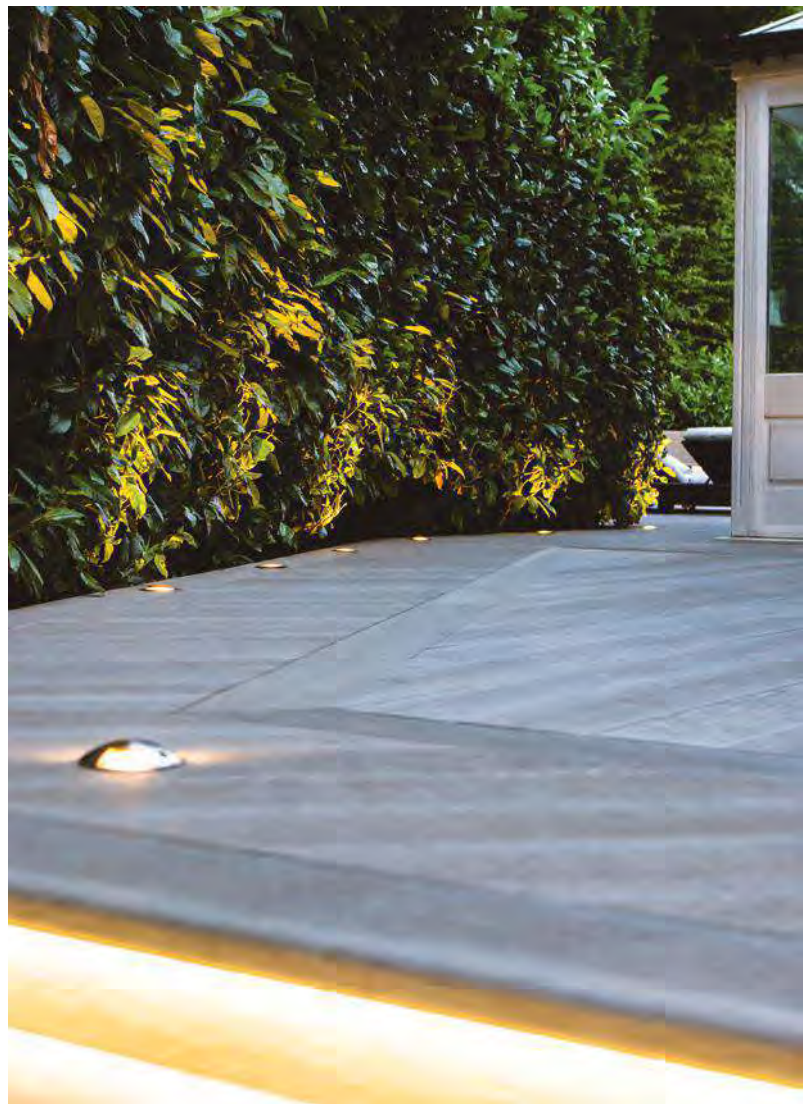

For the terrace's surface itself, Millboard Enhanced Grain decking in Smoked Oak was chosen both for its visual appeal and for its high-performance characteristics. Millboard's flexible Bullnose edging was also used to create a chic curved seating area. The whole installation has great slip-resistance, even in the wet, and requires minimal maintenance to sustain the deck's good looks.

Enhanced Grain Smoked Oak



"Millboard decking provided an ideal surface for what the clients required. It looks superb and it needs little or no maintenance to stay that way."

INSTALLER

RESIDENTIAL CASE STUDY

Vicar's Hill, Ladywell

The steep slopes of the existing garden at this property consisted largely of an uneven grass lawn and a few tired plants. It offered little to the owners and their three children, so they commissioned a designer to create a garden that all members of the family could use for relaxation and play.

The garden has been transformed into a space with distinctive areas for relaxing and having fun. Millboard decking has been used to create a raised platform at the entrance to the house, a mid-level deck extending out over the area below, overlapping steps that lead from the lawn area to a sunken trampoline, and a sundeck on top of a new garden studio.

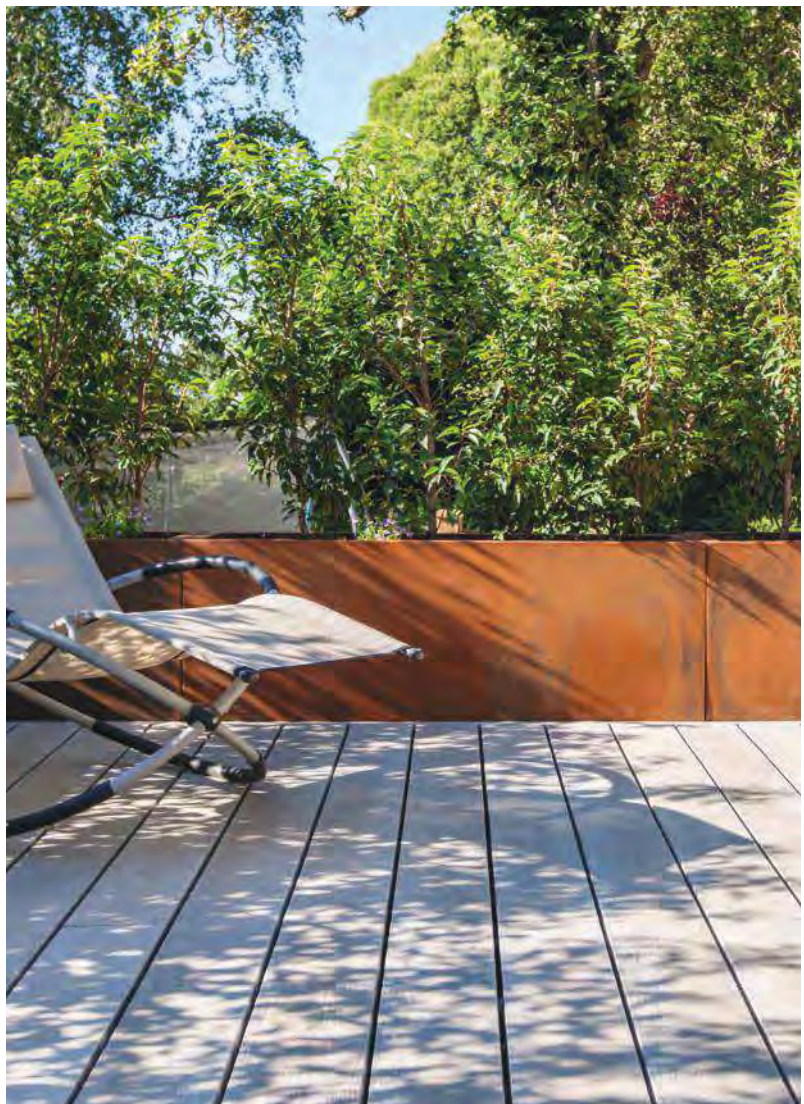



Millboard's Plas-Pro sub-frame components were used to ensure all the underlying structures will last as long as the decks they support.

Requirement

New design for multi-level garden

Project location

London, UK

Designer

Simon Orchard Garden Design



Enhanced Grain Smoked Oak

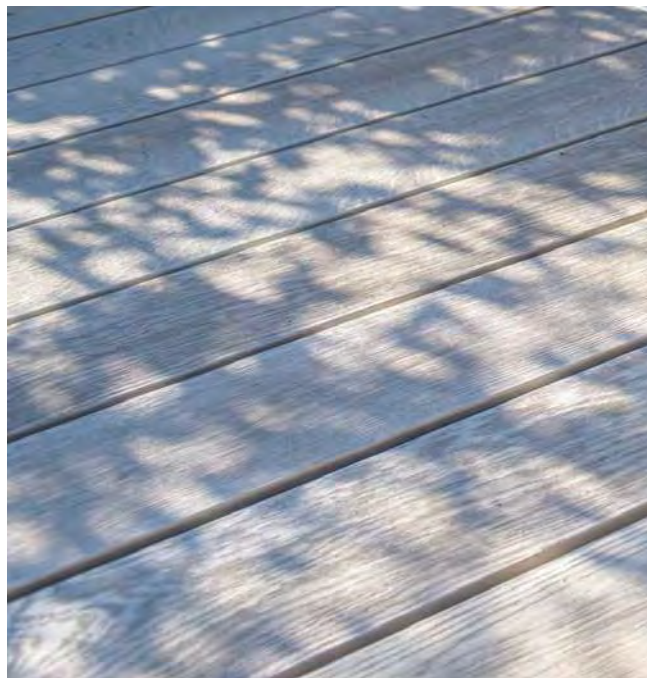

"Millboard was the perfect choice for this project, offering great performance and requiring little maintenance on the part of my busy clients. It's a great product."

GARDEN DESIGNER SIMON ORCHARD GARDEN DESIGN

COMMERCIAL CASE STUDY

East India Dock, London

In March 2017, Studio RHE, the London-based architecture and design practice, set out their plans to remodel Clove Crescent, East India Docks. The space would provide a new public realm, become a 'workplace of the future' and an icon of the capital's regeneration.

Millboard supplied 860m² of Enhanced Grain decking in Golden Oak, together with matching fascia boards. Representatives from Millboard offered technical design assistance to Studio RHE throughout the project.



Studio RHE's £25m project includes cost-effective office spaces flanked by cutting-edge amenities and relaxing communal areas. The central public water garden features an oasis of trees, landscaped ponds and seating. Studio RHE's decision to use Millboard decking throughout was based on the product's durability, its suitability for use in a wet zone and for its stunning good looks.

Enhanced Grain Golden Oak



"We were looking to create a boardwalk feel to the edge of the proposed public realm to give a warmer natural touch to the water's edge, adjacent to vibrant and verdant planting. As the public realm included a water garden and was open to the public, slip resistance was one of the most important requirements to the project."

ARCHITECT STUDIO RHE

COMMERCIAL CASE STUDY

Southampton Harbour Hotel

A bustling port and gateway to the Solent, Southampton Harbour also enjoys an international reputation for hosting the annual Boat Show. In recent years, the Ocean Village development has been adding to the area's prestige.

HGP Architects were engaged to create a five-star hotel for the marina and they came up with a spectacular design. Southampton Harbour Hotel looks like a luxury ocean liner moored on the waterfront, with terraces on multiple levels. High-end decking was required for all the terraces, and as well as looking good, materials had to be able to withstand the waterside location: slip-resistant and non-rot properties were vital.



The 1500m² installation is built on a Plas-Pro subframe and perfectly meets the brief for a durable and glamorous finish. The hotel recently won the prestigious C&IT Hotel of the Year award – a well deserved win for a boldly imagined property.

Our Flexible Bullnose Edging in Burnt Cedar was also used to create a visual contrast to the step up to the decking.

Enhanced Grain Smoked Oak





The Collection:

Weathered Oak

Create an atmosphere with our timeless, elegant boards





Time honoured style

Beautifully aged in appearance, our Weathered Oak collection is moulded from over a century old oak boards and is hand-coloured with authentic tones. Providing a timeless look, Weathered Oak retains its natural beauty and offers a surface with minimal maintenance and very high slip-resistance even in wet conditions.

200 x 3600 x 32mm
1.36 boards per m²



Weathered Oak Vintage

Achieve the classic beauty of a natural, weathered oak finish. Vintage is styled with darker tones that work perfectly in country retreats, coastal getaways and chic city courtyards.

Tastefully aged and utterly timeless, our Vintage colour option adds a stately and refined look to any space.

Board size	200 x 3600 x 32mm
Coverage	1.36 boards per m ²
Product code	MDW200V



Subframe
See page 60



Alternative uses
See page 80



Product samples
See page 82



Discover more about Vintage:
millboard.co.uk/vintage

Find an Approved Installer or Premier Distributor:
millboard.co.uk/locator



"The Vintage colour enabled us to cultivate the traditional country garden look that we wanted."

Theo Homeowner



Weathered Oak Driftwood

Our Driftwood boards have the incomparable look of sea-washed timber. Driftwood's subtle hue and characterful texture create an easy, relaxed style, ideal for laid-back coastal living.

Reminiscent of tidal landscapes, Driftwood creates a bohemian, escapist getaway and works perfectly alongside swimming pools and outdoor features.

Board size	200 x 3600 x 32mm
Coverage	1.36 boards per m ²
Product code	MDW200D



Subframe
See page 60



Alternative uses
See page 80



Product samples
See page 82



Discover more about Driftwood:
millboard.co.uk/driftwood

Find an Approved Installer or Premier Distributor:
millboard.co.uk/locator



Weathered Oak

Embered

Richly textured and dramatically chic, Embered provides a sensational stage or backdrop to a glamorous outdoor space.

By combining the look of Eastern heritage techniques with contemporary engineering, Millboard's Embered boards achieve the sought-after style whilst also maintaining stain and fade resistance.

Board size	200 x 3600 x 32mm
Coverage	1.36 boards per m ²
Product code	MDW200R



Subframe
See page 60



Alternative uses
See page 80



Product samples
See page 82

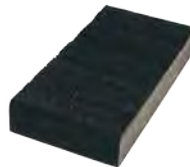

Discover more about Embered:
millboard.co.uk/embered

Find an Approved Installer or Premier Distributor:
millboard.co.uk/locator



"The decking boards have arrived, and they are absolutely gorgeous. Even better than imagined. We will certainly be showing these off."

Mr & Mrs Robinson Homeowners



RESIDENTIAL CASE STUDY

Burnham-on-Sea, Somerset

GreenBird Gardening Ltd, based in Portishead, North Somerset, was commissioned to design an entirely fresh outdoor scheme for this seaside property. Alongside their planting scheme, GreenBird's proposed hard landscaping features included an expansive deck where the owners could relax and enjoy alfresco dining.

The new garden creates a wonderfully relaxed feel and, thanks to subtle lighting, is as enjoyable after dark as during the daytime.

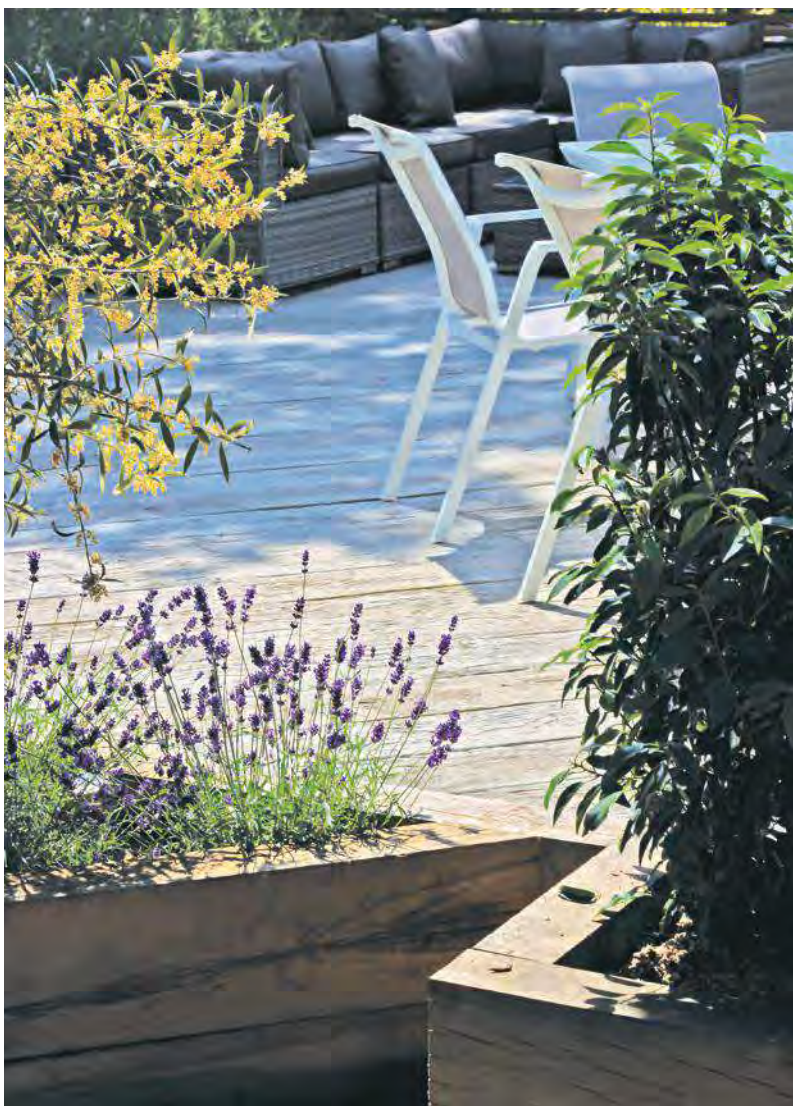

As a Millboard Approved Installer, GreenBird Gardening knew Millboard's Weathered Oak in its Driftwood guise would be the ideal complement to the rest of their design, with its characterful grain supplying the instant impression of age. The superb looks are matched by its performance. Unlike wood, it will not rot, warp or split, and it needs minimal maintenance. Food and drink spills can just be wiped away without leaving stains. Last but not least, Weathered Oak's excellent slip-resistance means that even after rain, the deck can be safely enjoyed.

Weathered Oak Driftwood



"When Chris at GreenBird first proposed such an amount of decking, we were quite nervous about the maintenance required. After seeing a sample of Millboard decking, we were reassured. The end result is superb, both exceeding our expectations and allaying any initial worries that we had about keeping it looking good in the future."

HOMEOWNER

RESIDENTIAL CASE STUDY

Newent, Gloucestershire

The discerning homeowners wanted to transform their relatively plain 1960s property into something more suited to their tastes. Engaging a reputable construction company, they embarked on a significant overhaul, which included outdoor landscaping.

The extensive outdoor area blends a tasteful mix of materials and includes a covered eating area, a nature pond and a swimming pool. Millboard Weathered Oak decking was applied to the main decked area, the walkways to pond and pool, and even a sliding cover for the pool.



Millboard Weathered Oak decking in the Embered shade was chosen for all the decked areas. Providing the distinctive character of 100-year-old timber, but with the performance of a modern, cutting-edge material, it is perfectly suited to waterside environments and maintains high slip-resistance even when wet.

Weathered Oak Embered



"We thoroughly enjoyed working with the product. Combined with the Plas-Pro sub deck material, fixed with stainless steel fixings, our client can rest assured that the Millboard deck will outlast all of us!"

DIRECTOR T J VEALE CONSTRUCTION LTD

COMMERCIAL CASE STUDY

Royal Botanic Gardens, Kew

Kew Gardens seek to preserve the natural environment, protect endangered species, as well as discovering new and sustainable uses for plants and fungi. It is estimated that the 14,000 trees that have been planted at Kew draw around 8.6 tonnes of potentially harmful carbon dioxide from London's air annually.

Kew Gardens is a UNESCO World Heritage Site and one of London's top tourist attractions, playing host to more than 3 million visitors annually. With such heavy footfall, durability was a key consideration when specifying materials for flooring and furniture applications and Millboard decking was selected as the best fit. The Millboard projects team provided the contractor with ongoing support, including site visits and close collaboration with the designers and installers throughout.



Every length of Millboard decking is designed to look and feel indistinguishable from real timber, without the associated drawbacks. It is this attention to detail that has led Kew Gardens and other leading establishments to specify the Enhanced Grain and Weathered Oak range for walkways, furniture and cladding applications.

A beautiful, reliable and eco-conscious solution that will help to encourage future generations to live life outside.

Weathered Oak Embered

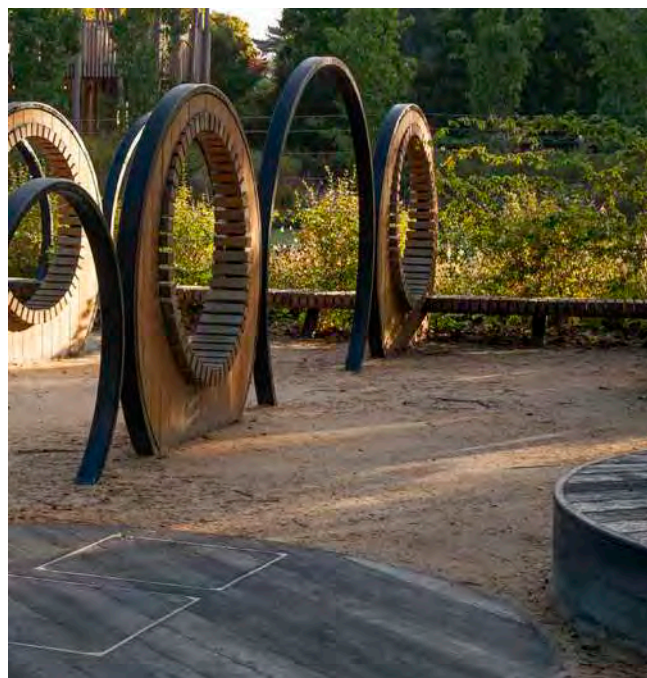

“Having previously specified Millboard products on design projects for schools, I knew that I could rely on the range for its durability and slip-resistant properties, on top of its natural aesthetic. The black hues of these boards provide a good backdrop for foliage plants, allowing their vibrant colours to really shine through. The Children’s Garden incorporates an amphitheatre design with curved benches; we achieved a good radius by simply bending the fascia boards to create a seamless finish that’s not always possible with timber. The Millboard decking was installed just as easily as real wood, and facilitated techniques like tapered cuts, which help to create that flawless finish we were looking for. It blends really well.”

LANDSCAPE ARCHITECT KEW GARDENS

COMMERCIAL CASE STUDY

Boardwalk, Falkirk

Formerly known as The Wheelhouse, the popular Boardwalk venue near to the Falkirk Wheel has been completely revamped under new owners Cawley Hotels. They were keen to create outdoor spaces for their customers to enjoy, but the wooden decks they had in mind would be time-consuming to maintain and become slippery during and after any wet weather.

With high footfall, the outdoor areas around Boardwalk demanded a flooring material that would require minimal maintenance and provide excellent slip-resistance. The Boardwalk's architects opted for Millboard's Weathered Oak Driftwood, a perfect match for the nautical restaurant.



Their new walkway and external terrace area beautifully showcases the romantic charm of the Weathered Oak range. Perfectly matched with sea-worn rope, the installation has become a highlight of the area and the owner is looking to include similar concepts within future restaurant designs.

Weathered Oak Driftwood

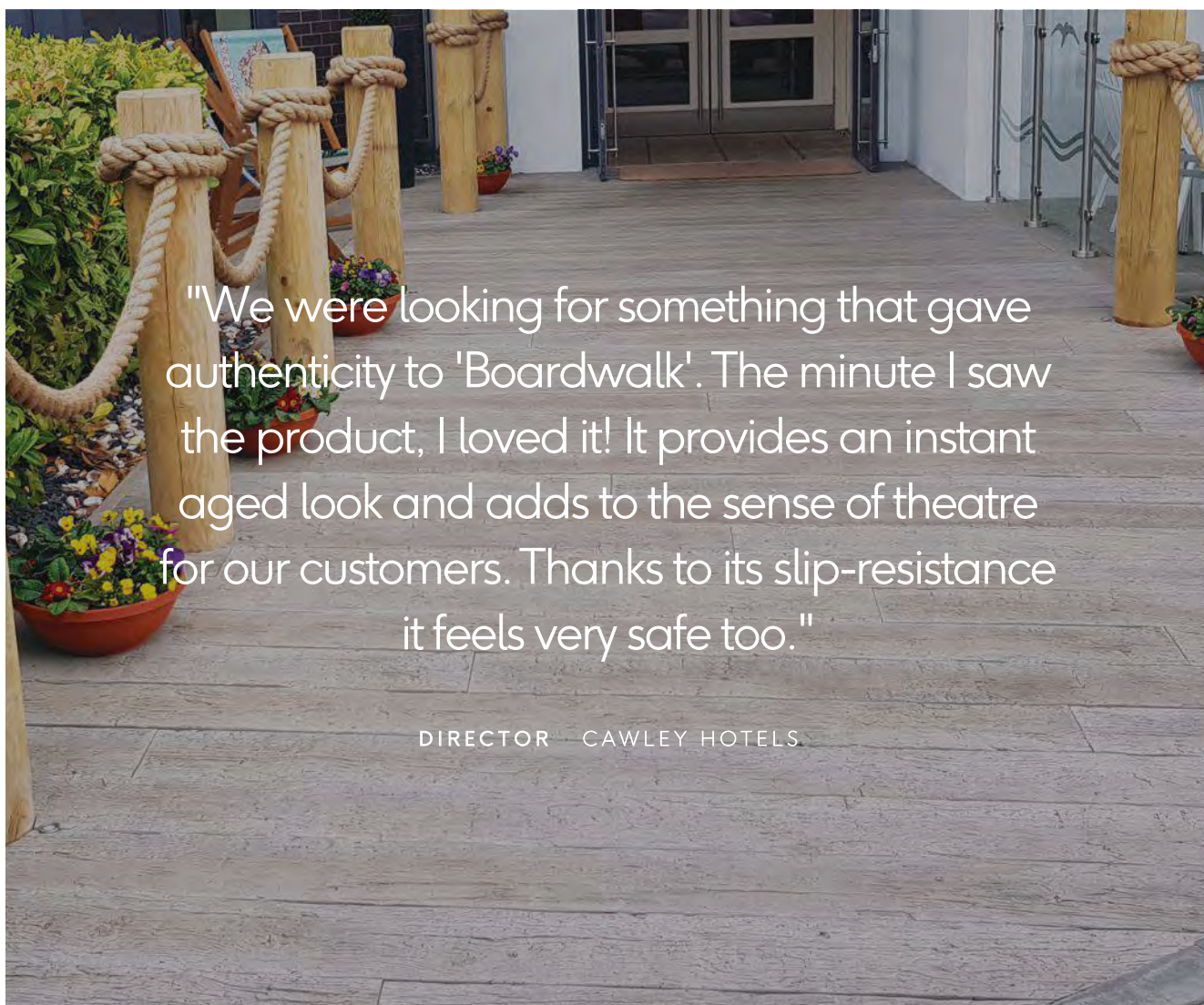

"We were looking for something that gave authenticity to 'Boardwalk'. The minute I saw the product, I loved it! It provides an instant aged look and adds to the sense of theatre for our customers. Thanks to its slip-resistance it feels very safe too."

DIRECTOR CAWLEY HOTELS

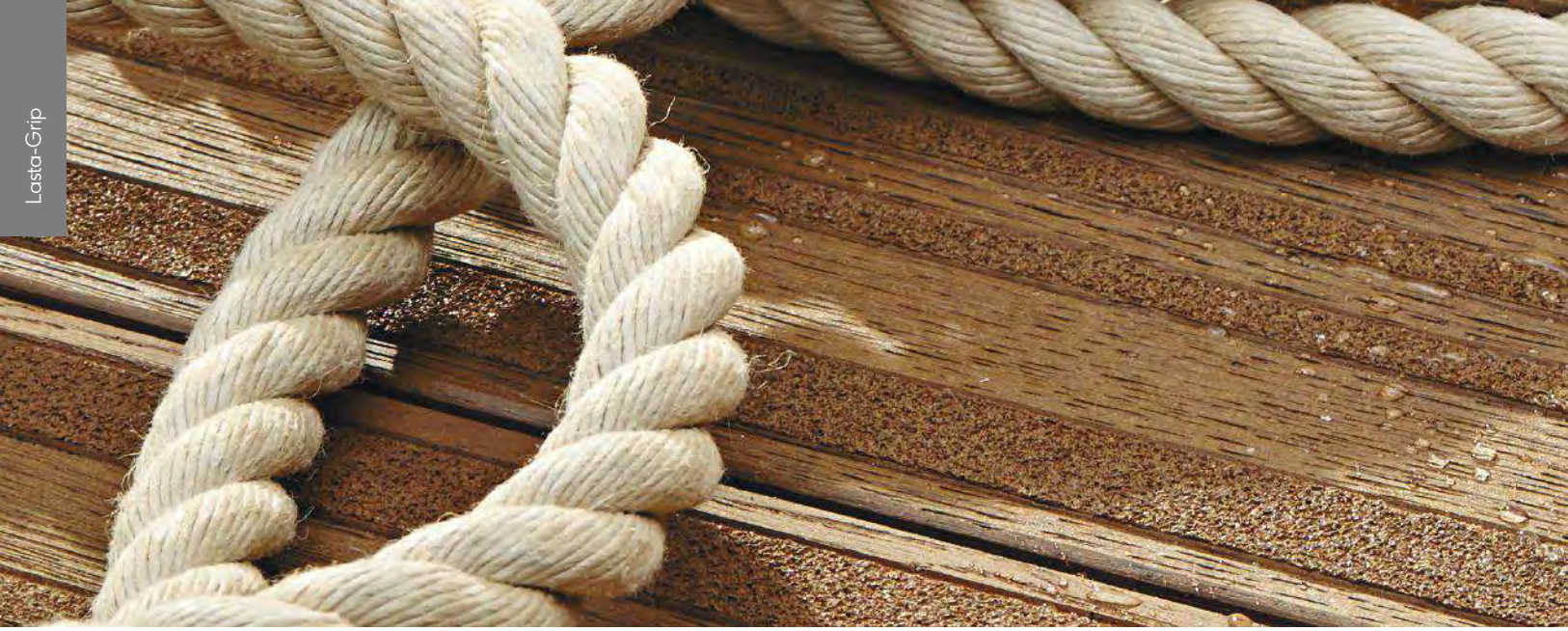

The Collection:

Lasta-Grip

Safety-focused boards with style

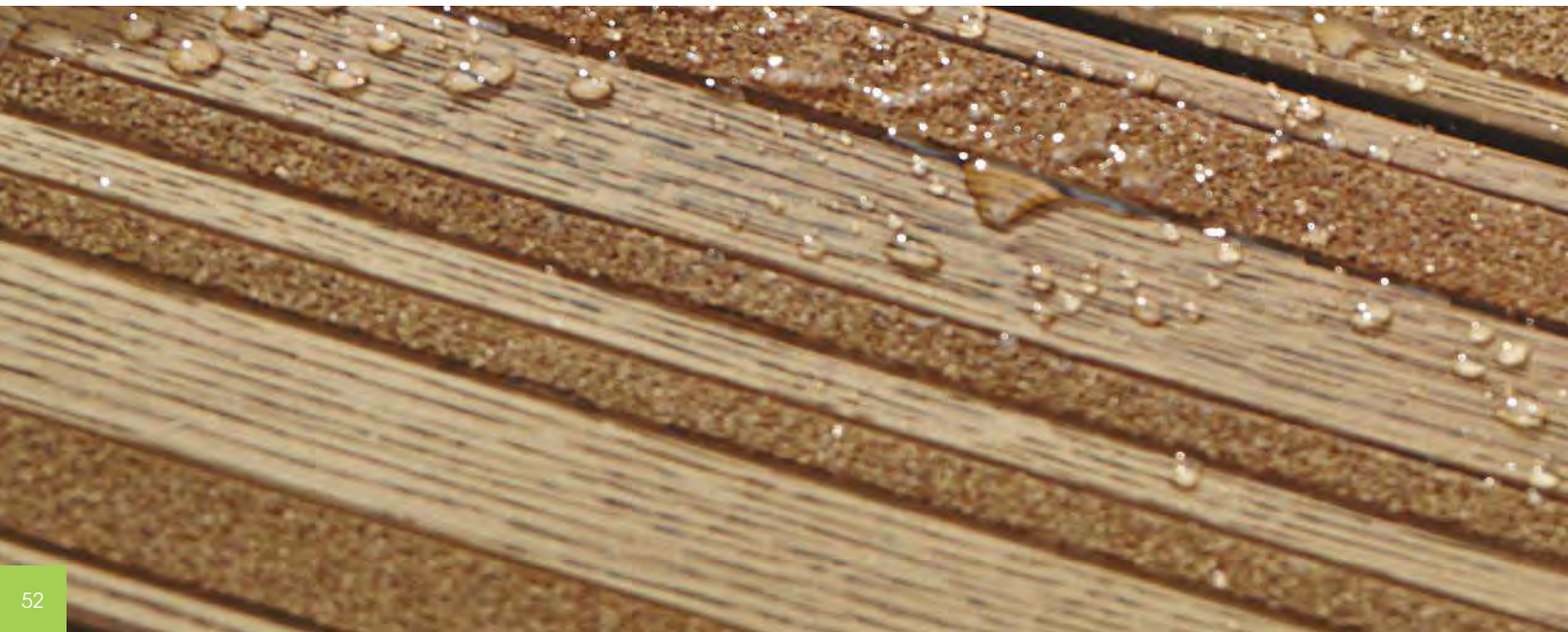

A gripping design

Our Lasta-Grip® collection combines the attractive appearance of our Enhanced Grain boards with a unique textured design that offers the ultimate slip-resistance, without the rough feel of conventional gritted strip boards. Perfect for commercial areas where safety is paramount, but appearance is important.

200 x 3600 x 32mm
1.36 boards per m²



Lasta-Grip Coppered Oak

Lasta-Grip in the popular Coppered Oak shade provides a tasteful decking option for areas where the shades of hardwood are desirable but visible slip-resistant measures are required. The beautiful wood grain is still clearly evident, and the textured strips provide reassurance that safety needs are fully met.

Board size	200 x 3600 x 32mm
Coverage	1.36 boards per m ²
Product code	MDL200C



Lasta-Grip Golden Oak

Maintaining the same appeal as in the Enhanced Grain range, our Lasta-Grip Golden Oak decking provides the elegant look of freshly sawn Oak. Combining the distinctive wood grain with textured strips for maximum slip-resistance, these decking boards are as safe as they are stylish, and suitable for both residential and commercial environments.

Board size	200 x 3600 x 32mm
Coverage	1.36 boards per m ²
Product code	MDL200G



Discover more about Lasta-Grip decking:
millboard.co.uk/lasta-grip-decking

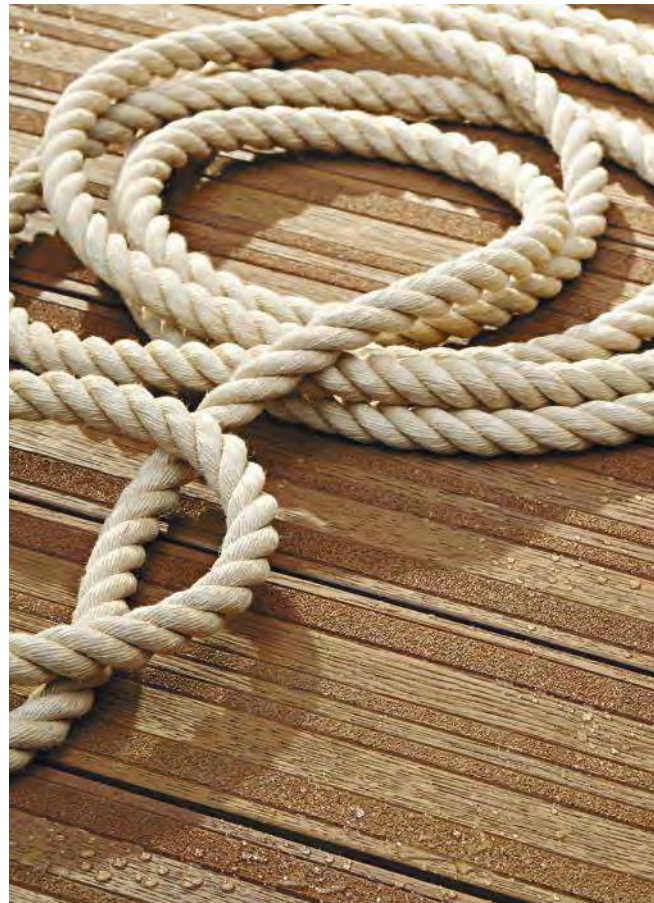

The Collection:

Edging & Fascia

The perfect finishing touch

Completing the look

Millboard edging continues the beautiful wood grain right round the edge profile to maintain the authentic wood look.

Designed to resist high wear points, our edging profiles and fascia boards come in all of the Millboard colours to match the rest of your deck. And the specialist flexible edging fits easily around curved edges for a truly distinctive outdoor space.



Edging & Fascia

Open up a whole range of possibilities – from under-lip lighting to coping for planters and seating – with Millboard's Edging and Fascia.

Our finishing touches add exceptional stability and aid ease of installation on steps and other exposed edges. Achieve a refined look that adds distinction to any setting.

Square Edging

Construction: Polymer resin core/Lastane® surface

Size: 50 x 3200 x 32mm

Fascia

Construction: Polymer resin core/Lastane® surface

Size: 146 x 3200 x 16mm

Flexible Bullnose Edging

Construction: Flexible polymer resin core/Lastane® surface

Size: 50 x 2400 x 32mm

Bullnose Board

Construction: Polymer resin core/Lastane® surface

Size: 150 x 3200 x 32mm

-
- ← Smoked Oak with Bullnose Board
 - ↓ Brushed Basalt with Flexible Bullnose Edging and Fascia
 - ↓ Golden Oak with Flexible Bullnose Edging and Fascia





Edging & Fascia: Colour options

1 Smoked Oak/Driftwood

Flexible Bullnose Edging: MEBF50D
 Square Edging: MEUN32D
 Fascia: MFN320D
 Bullnose Board: MEBB150D

4 Burnt Cedar/Embered

Flexible Bullnose Edging: MEBF50R
 Square Edging: MEUN32R
 Fascia: MFN320R
 Bullnose Board: MEBB150R

7 Jarrah

Flexible Bullnose Edging: MEBF50J
 Square Edging: MEUN32J
 Fascia: MFN320J
 Bullnose Board: MEBB150J

2 Limed Oak

Flexible Bullnose Edging: MEBF50L
 Square Edging: MEUN32L
 Fascia: MFN320L
 Bullnose Board: MEBB150L

5 Golden Oak

Flexible Bullnose Edging: MEBF50G
 Square Edging: MEUN32G
 Fascia: MFN320G
 Bullnose Board: MEBB150G

8 Vintage

Flexible Bullnose Edging: MEBF50V
 Square Edging: MEUN32V
 Fascia: MFN320V
 Bullnose Board: MEBB150V

3 Brushed Basalt

Flexible Bullnose Edging: MEBF50B
 Square Edging: MEUN32B
 Fascia: MFN320B
 Bullnose Board: MEBB150B

6 Coppered Oak

Flexible Bullnose Edging: MEBF50C
 Square Edging: MEUN32C
 Fascia: MFN320C
 Bullnose Board: MEBB150C

9 Antique Oak

Flexible Bullnose Edging: MEBF50A
 Square Edging: MEUN32A
 Fascia: MFN320A
 Bullnose Board: MEBB150A

The Collection:

DuoSpan™ and DuoLift™

Engineered strength and design versatility

The finest support

Our DuoSpan subframe and DuoLift support systems enable straightforward construction of complex decks, screening and landscaping structures. These innovative new additions to Millboard's range have been designed to the highest of British and EU standards.

The patent pending systems combine lightweight ease of handling with solid stability once installed.



The intuitive DuoSpan and DuoLift systems create durable and distinctive designs.

DuoSpan and DuoLift. Engineered strength and design versatility.

Representing a unique landscape construction frame, DuoSpan combines the strength of aluminium with the design flexibility of recycled plastic. This combination enables distinctive decking designs and outdoor structures that would be difficult with most conventional subframes, and its slot-and screw assembly, assists with easier installations.

The DuoLift joist support system provides substantial height flexibility within four stackable components, removing the challenge of various fixed-height pedestals over a single area, and provides enhanced ease of installation, together with superior load bearing.

DuoSpan and DuoLift can both be used with a wide range of decking and cladding materials.

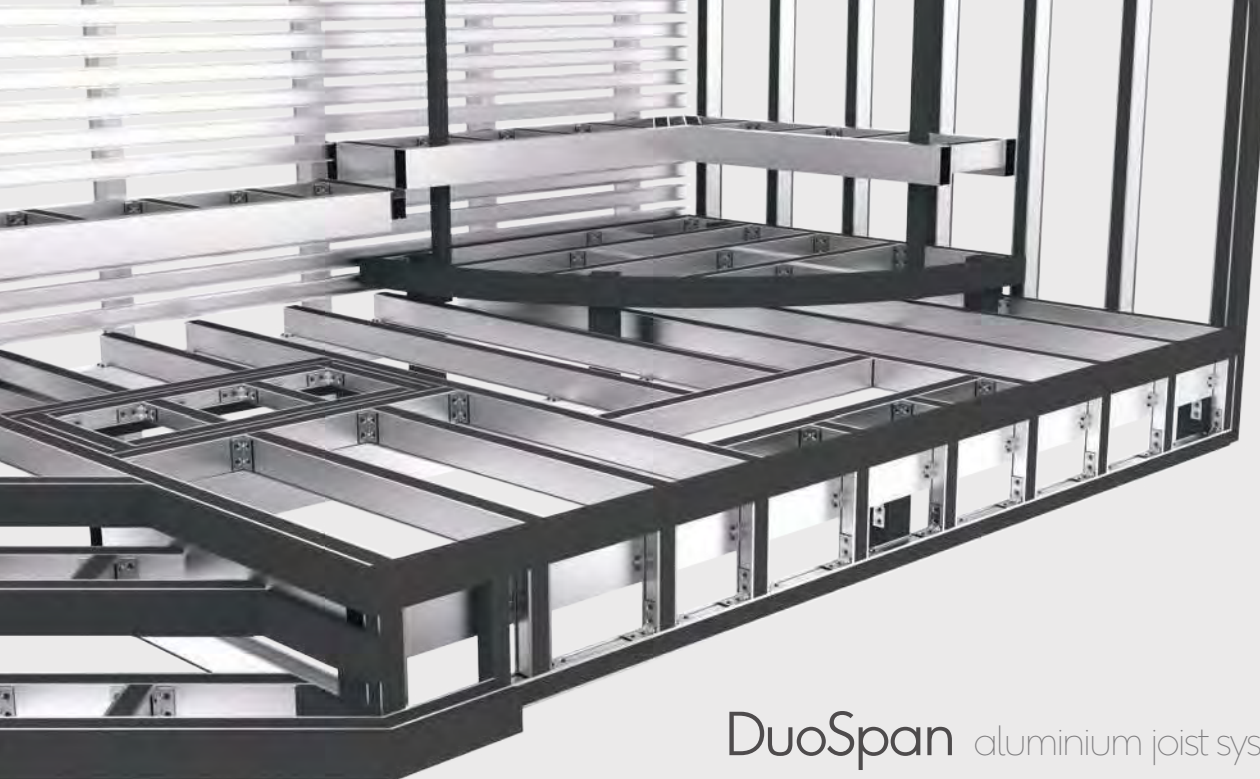

DuoSpan aluminium joist system

DuoSpan is packed with innovative features that make installation success a virtual certainty, even with distinctive and challenging designs. DuoSpan is available in a low level profile, or with deeper profiles for longer spans.

www.millboard.co.uk/duospan



DuoLift twist-lock support system

Simple stackability for height flexibility – DuoLift provides subframe support that just works. The Self-Levelling Joint is designed for ease and speed of installation. An adjustable and problem-solving solution from Millboard.

www.millboard.co.uk/duolift

DuoSpan

DuoSpan is a unique landscape construction frame, combining the strength of aluminium with the design flexibility of recycled plastic. This combination enables distinctive design opportunities for decking and outdoor structures that would be impossible with conventional subframes.

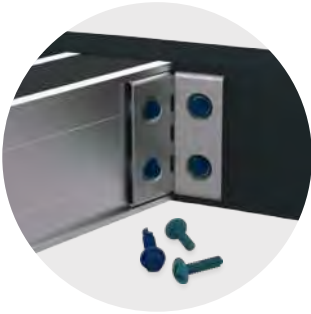

Flexible connectivity

Multiple bracket types facilitate all types of joints, including Flexible Brackets for non-standard angles.

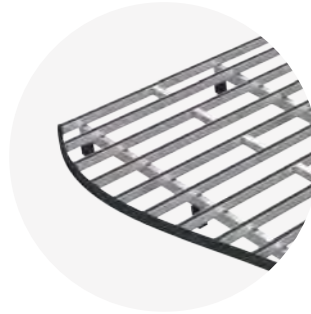

Unique curved constructions

The combination of rigid DuoSpan with flexible Plas-Pro enables the construction of stunning curved formations.



Slot-and-screw assembly

Screw-locating grooves and self-drilling screws ensure accurate alignment and a fast fix that's right first time.



Exceptional spans

The DuoSpan 99mm Joist provides an 1800mm span in residential applications, reducing posts or joist supports required.

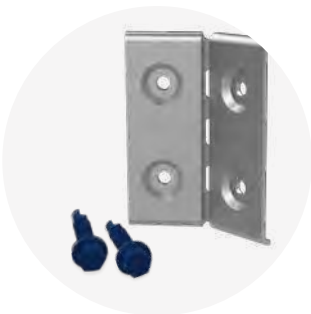

Corrosion-resistant

Galvanic corrosion between different metals is minimised with our cathodic barrier fixings.



Simple, stable fixing

Decking and cladding can be easily and securely screwed into the DuoSpan Joist Insert at almost any angle.

DuoLift

The DuoLift joist support system was designed to make installation significantly easier and to ensure successful outcomes. Providing substantial height flexibility within four stackable components, DuoLift removes the common problem of having to order varying height pedestals for a single area.



Superior load bearing

The larger 114mm diameter Joist Cradle and 220mm diameter Foot provide enhanced dispersion of point loading.



Micro-adjustable

The height-adjustment ring on the DuoLift Joist Cradle provides precision 1mm adjustments for every quarter turn.



Self-levelling

The 20mm Self-Levelling Joint component is added for height elevation of more than 35mm and ensures level surfaces.



Stack-up support

Eliminating conventional fixed-height pedestals, stackable 45mm Risers provide on-site flexibility and accuracy.



Locking tabs

Locking tabs twist over the bottom lip of DuoSpan Joists for secure anchoring or align with solid joists for a screw fixing.



Visible twist-lock

Clear indicators confirm that stackable components are properly locked together – just insert, twist and lock.

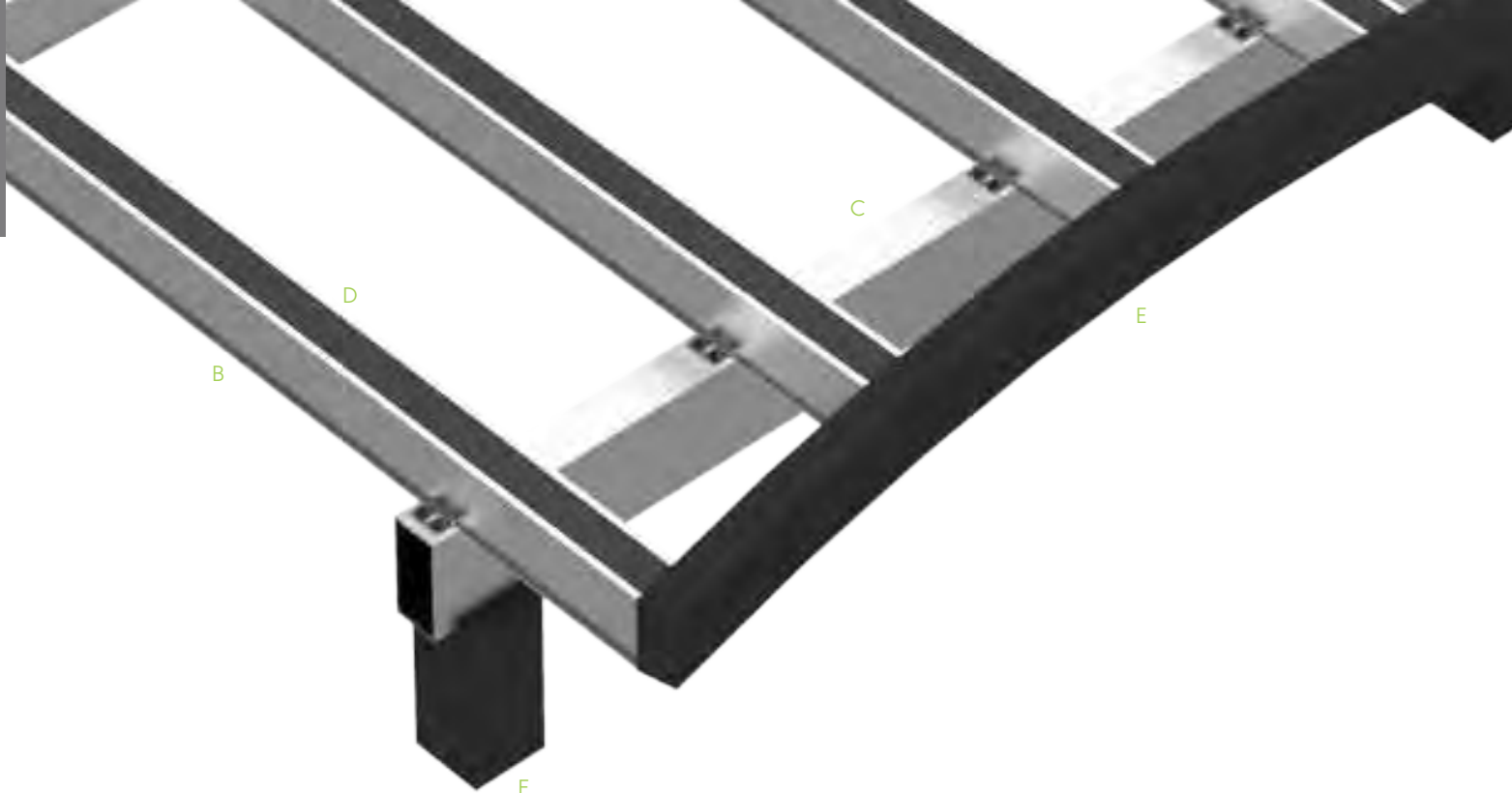

DuoSpan

DuoSpan profiles

Contents	Dimensions	Material	Code
A DuoSpan 51mm Joist	51 x 68 x 3600mm	Aluminium	K5168J360
B DuoSpan 99mm Joist	99 x 68 x 3600mm	Aluminium	K9968J360
C DuoSpan 136mm Beam	136 x 63 x 3600mm	Aluminium	K1363B360



A



D



B



E

DuoSpan insert

Contents	Dimensions	Material	Code
D DuoSpan Joist Insert	25 x 50 x 3000mm	Recycled plastic	K0205B300

Plas-Pro

Contents	Dimensions	Material	Code
E Plas-Pro Fascia Support	100 x 25 x 3000mm	Recycled plastic	P0210B300
F Plas-Pro Post	100 x 100 x 3000mm	Recycled plastic	P1010B300

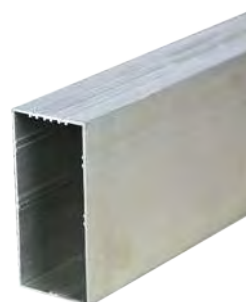

Accessories and fixings

Joist bracket sets for DuoSpan 51mm Joist

Contents	Quantity	Dimensions	Material	Box code
DuoSpan 51 90° Angle Bracket	10	–	Aluminium	K51RP010
DuoSpan Hex-head Screw	42	5.5 x 25mm	Cathodic barrier coated s/s	
DuoSpan 51 Flexible Bracket	10	–	Aluminium	K51FP010
DuoSpan Hex-head Screw	42	5.5 x 25mm	Cathodic barrier coated s/s	
DuoSpan Pan-head Screw	20	5 x 25mm	Cathodic barrier coated s/s	
DuoSpan 51 Straight Connector	10	–	Aluminium	K51LP010
DuoSpan Hex-head Screw	42	5.5 x 25mm	Cathodic barrier coated s/s	

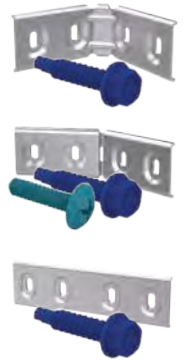

Joist bracket sets for DuoSpan 99mm Joist

Contents	Quantity	Dimensions	Material	Box code
DuoSpan 99 90° Angle Bracket	10	–	Aluminium	K99RP010
DuoSpan Hex-head Screw	42	5.5 x 25mm	Cathodic barrier coated s/s	
DuoSpan 99 Flexible Bracket	10	–	Aluminium	K99FP010
DuoSpan Hex-head Screw	42	5.5 x 25mm	Cathodic barrier coated s/s	
DuoSpan Pan-head Screw	20	5 x 25mm	Cathodic barrier coated s/s	
DuoSpan 99 Straight Connector	10	–	Aluminium	K99LP010
DuoSpan Hex-head Screw	42	5.5 x 25mm	Cathodic barrier coated s/s	



Hold-down clip

Contents	Quantity	Dimensions	Material	Box code
DuoSpan Hold-down Clip	30	–	Aluminium	K48CP030
DuoSpan Hex-head Screw	63	5.5 x 25mm	Cathodic barrier coated s/s	



Plas-Pro profile fixings

Contents	Quantity	Dimensions	Material	Box code
DuoSpan Bracket to Plas-Pro Screw	100	5 x 25mm	Cathodic barrier coated s/s	FD25P100
Plas-Pro to DuoSpan Screw	100	5 x 50mm	Cathodic barrier coated s/s	FD50P100



DuoLift

DuoLift has been developed by Millboard based on intimate knowledge of the challenges of installing decking on hard surfaces, and the shortcomings of conventional pedestal/cradle systems. It removes the arbitrary choice of pedestal heights, and instead provides a 15-60mm Joist Cradle with a sequence of support components that can raise the height to a maximum of 350mm.

Making installation easy

Every aspect of the installer's experience has been considered, and fine details of the design make height adjustment easier and give confidence when installing. The larger 114mm diameter of the Joist Cradle and the 220mm diameter of the Foot provide more effective load spreading.

Twist-lock system

To ensure the best solid fit, the DuoLift boasts the twist-lock system, rather than a loose stacking.

DuoLift unpacked

DuoLift Joist Cradle 15-60mm

10 pack: PMCP010

Providing an exceptional height range of 45mm, from 15-60mm, the DuoLift Joist Cradle enables precision height adjustment with 5mm markings on the side and each quarter turn of the adjustment ring representing a 1mm rise or fall. The Joist Cradle allows the installer to adjust the height whilst the joist is in place, locking tabs provide a secure finish once correct height has been determined.

DuoLift Self-Levelling Joint 20mm

10 pack: PMLP010

Adding 20mm to the height of the supports, the DuoLift Self-levelling Joint provides easy and effective levelling of a subframe up to 5°, ready for decking installation. Suitable for standing directly onto a solid substrate, or for providing a joint for a higher support.

DuoLift Riser 45mm

10 pack: PMRP010

The Riser component of the DuoLift system increases the height in increments of 45mm. It is capable of sitting directly onto a solid substrate under the Joist Cradle and Self-Levelling Joint or forming part of a higher stack with a foot beneath.

DuoLift Foot 45mm

10 pack: PMFP010

The DuoLift Foot provides a very stable footing for more elevated subframes, raising the height by 45mm and spreading the load further across the substrate, due to the 220mm base supporting a maximum combined height of 350mm.

DuoLift Acoustic Separation Pad 3mm

10 pack: PMAP010

Agglomerated cork and recycled rubber pads offer a layer of protection between joist supports and membranes, as well as providing an acoustic benefit.



Clicks into place



Twist-lock



Twist-lock



Simple stackability for height flexibility

Multiple height combinations from four sturdy components.
With a selection of components on site, installation delays can be avoided.

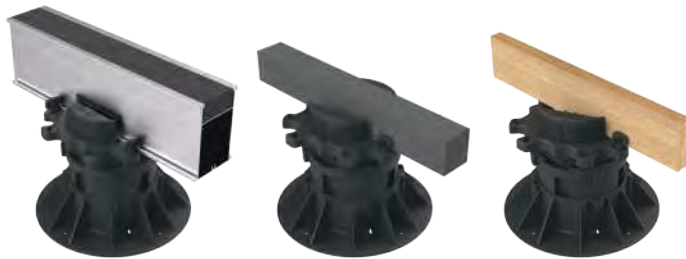
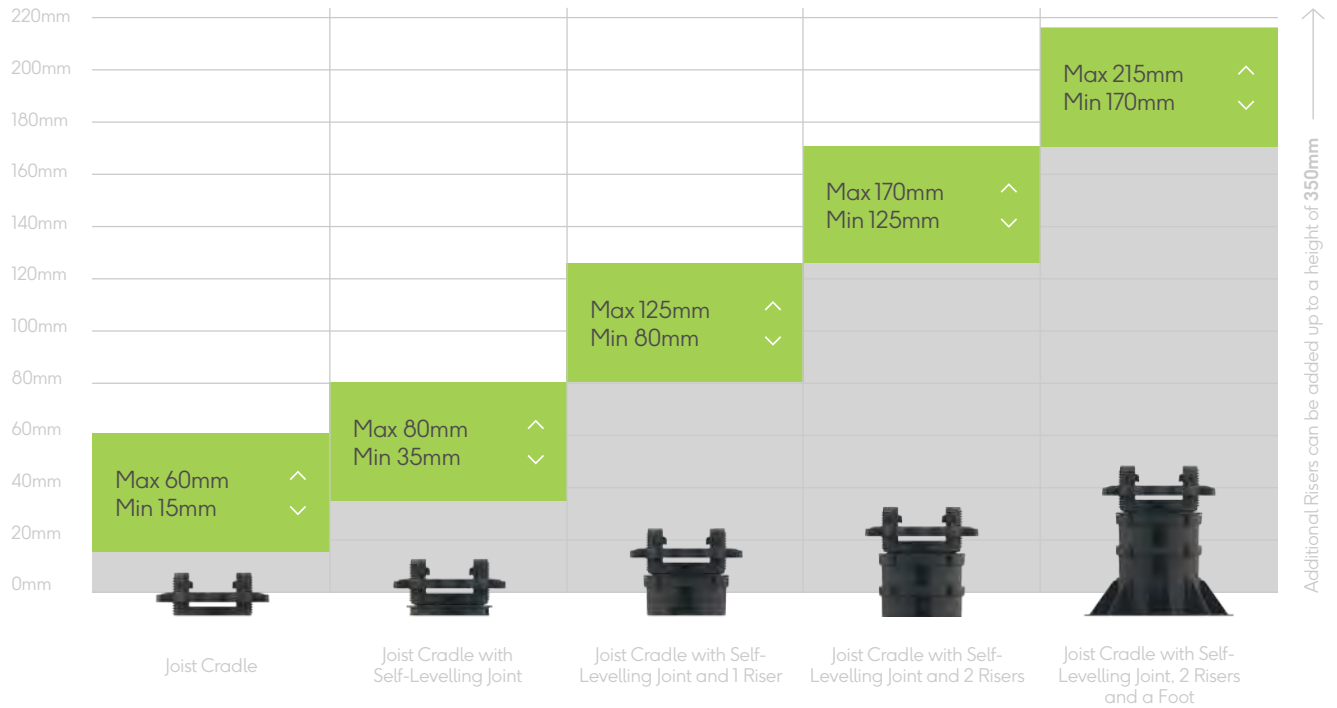

Universal support for all frame types

DuoLift is designed to support a range of joists from DuoSpan to Plas-pro to timber.

How many Joist Supports do I need?

Residential applications: 4 per m² Millboard decking*
Commercial applications: 7 per m² Millboard decking*

Contents	Quantity	Height	Pack Code
A DuoLift Joist Cradle	10	15-60mm	PMCP010
B DuoLift Self-Levelling Joint	10	20mm	PMLP010
C DuoLift Riser	10	45mm	PMRP010
D DuoLift Foot	10	45mm	PMFP010
E DuoLift Acoustic Separation Pad	10	3mm	PMAP010

* Approximate number - quantities may vary according to project design and choice of subframe used.



The Collection:

Components & Materials

Everything you need for installation success

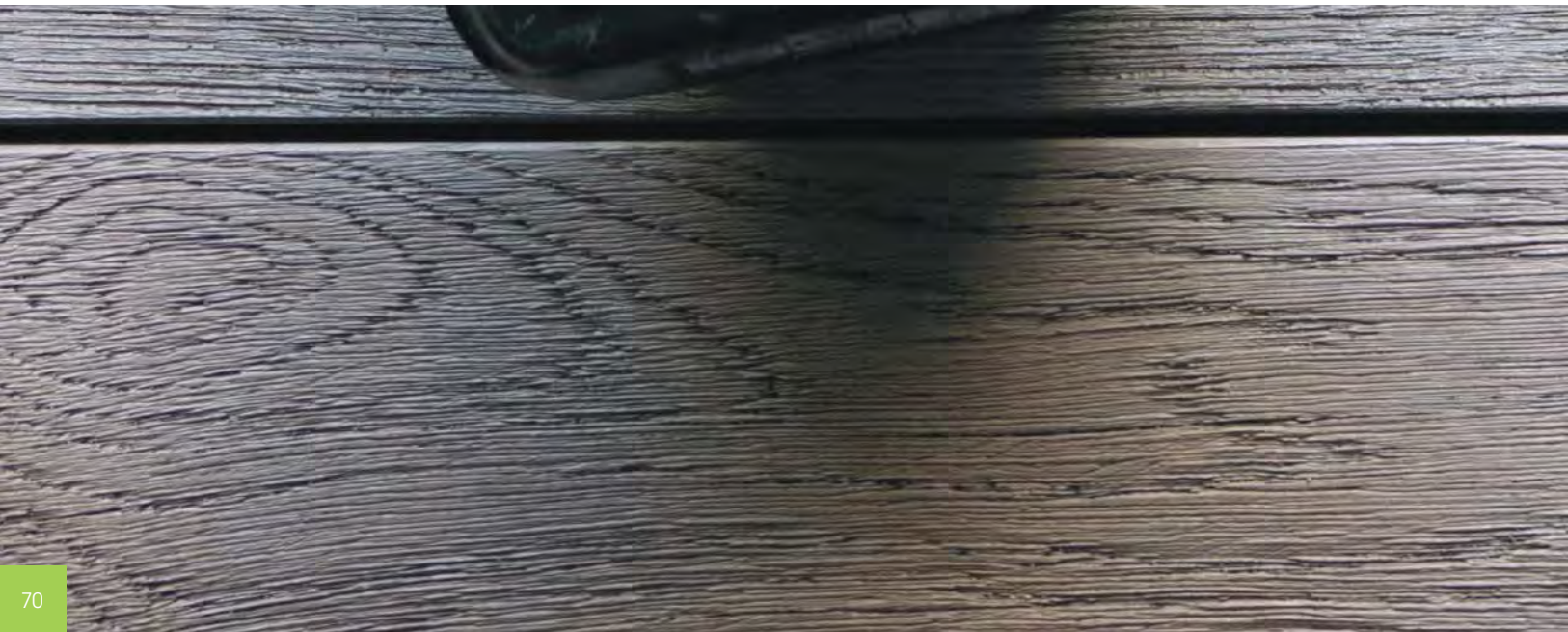

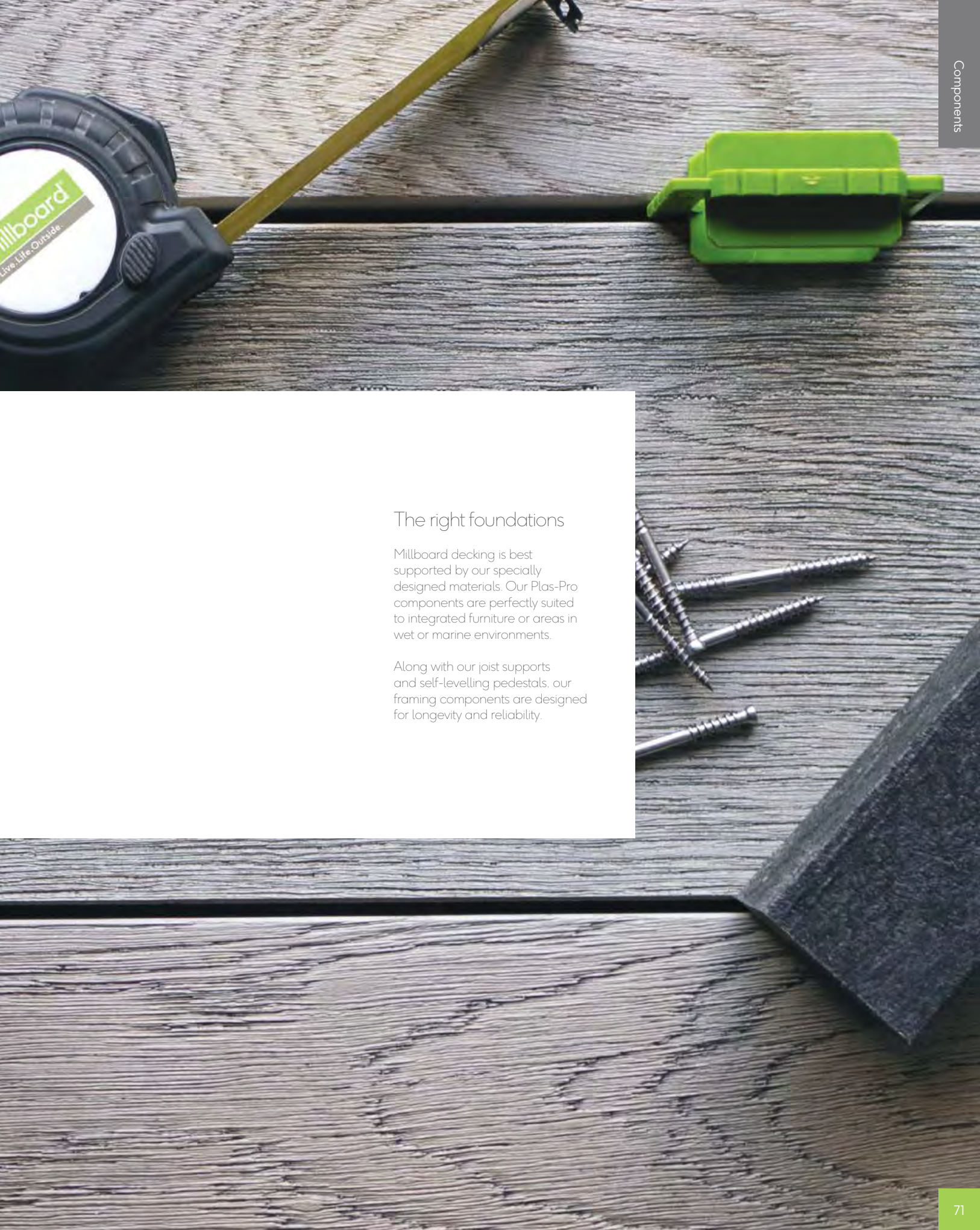

The right foundations

Millboard decking is best supported by our specially designed materials. Our Plas-Pro components are perfectly suited to integrated furniture or areas in wet or marine environments.

Along with our joist supports and self-levelling pedestals, our framing components are designed for longevity and reliability.



Plas-Pro

Plas-Pro is an excellent alternative to timber for constructing supporting structures for decks, seating, planters and more. It is incorporated within our comprehensive DuoSpan aluminium subframe system, but it can also be used on its own in low-height areas, such as roof terraces, and in waterside areas where use of metal is not advisable.

Constructed from recycled plastic, Plas-Pro is strong, versatile and easy to work with. Available in a range of sizes to act as posts, joists and bearers, it can be cut and drilled just like wood, yet never rots even when placed in water.

The flexibility of Plas-Pro means that it can also be used to create unique and special outdoor constructions, incorporating curves and twists that would be impossible with conventional materials.

Plas-Pro 125 x 50mm Joist/Bearer

Designed to be used in conjunction with Plas-Pro 100 x 100mm Posts when installed over a soil/earth base.

Dimensions 125 x 50 x 3000mm

Product Code P1205B300



Plas-Pro 50 x 50mm Joist

Designed to be used in conjunction with the DuoLift system when installed over a solid/stable substrate.

Dimensions 50 x 50 x 2400mm

Product Code P0505B240



Plas-Pro 60 x 30mm Joist

Designed to be used in low-level areas with a solid/stable base. Not to be raised with cradles.

Dimensions 60 x 30 x 2800mm

Product Code P0603H280



Plas-Pro 100 x 100mm Post

Designed to be used in conjunction with Plas-Pro 125 x 50mm Joist/Bearers when installed over a soil/earth base.

Dimensions 100 x 100 x 3000mm

Product Code P1010B300



Touch-up Coating

Put the finishing touches on exposed cut ends with Touch-up Coating. Supplied in 500ml tins, Touch-up coating is available in nine colours to match your choice of Millboard decking.



A note on colour variance

We go to extraordinary lengths to recreate the look of natural products and therefore intentionally add secondary toning colours. This painstaking process means that there may be variance within the same board or between boards.

Whilst every care is taken to ensure consistency, batch-to-batch colour variation is possible. We strongly recommend that you order all you need in one delivery to avoid too much variance. If you do have two batches, it is best to mix them, to blend the colours more seamlessly. It is best to lay the boards out before commencing installation.

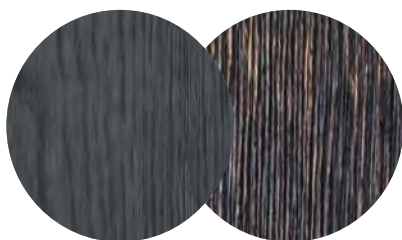

⬆ Colour tone may vary from batch to batch. Antique Oak has more variance between boards.



Antique Oak
500ml AP500A



Coppered Oak
500ml AP500C



Golden Oak
500ml AP500G



Limed Oak
500ml AP500L



Brushed Basalt
500ml AP500B



Smoked Oak/Driftwood
500ml AP500D



Jarrah
500ml AP500J



Burnt Cedar/Embered
500ml AP500R



Vintage
500ml AP500V

Durafix® fixings



Our decking system is complemented by our unique Durafix screws. These hidden fixings make installing Millboard straightforward.

With Durafix®, there's no need to pre-drill, countersink or use clip fixings. Simply screw them straight in to just below the surface. Millboard decking's innovative Lastane coating flexes back over the screw-heads, leaving a minimal witness mark.

Made from A2 stainless steel, the screws have a self-cutting tip, six-point torx head, and are waxed for ease of use. Each box of Durafix® fixings also includes a T15 hex-shank drill bit. You will need around 22 fixings for each length of Millboard decking for residential applications and 26 fixings for commercial applications.

Fixings	Quantity	Suitable for	Product code
4.5 x 60mm	Box of 250	Top down timber and DuoFix tool	FT60P250
4.5 x 45mm	Box of 250	Top down DuoSpan and Plas-Pro	FT45P250
4.5 x 35mm	Box of 100	Fascia	FT35P100

Duofix installation tool



Our patent pending DuoFix Side-Fixing Guide makes decking installation accurate and quick, resulting in a clean hidden fixing finish. This quality gives you a clean look, even when used with lighter coloured boards.

The Guide lays over the decking board and is suitable for board widths of 145-200mm, making it compatible with all Millboard decking boards, and even some softwood decking boards. When used in combination with Durafix® screws and the complimentary driver bit, the Guide aligns the screws perfectly and controls the fixing depth too.

The DuoFix Side-Fixing Guide provides a 6mm spacing between boards.

Discover more about fixings and accessories:
millboard.co.uk/subframe-accessories

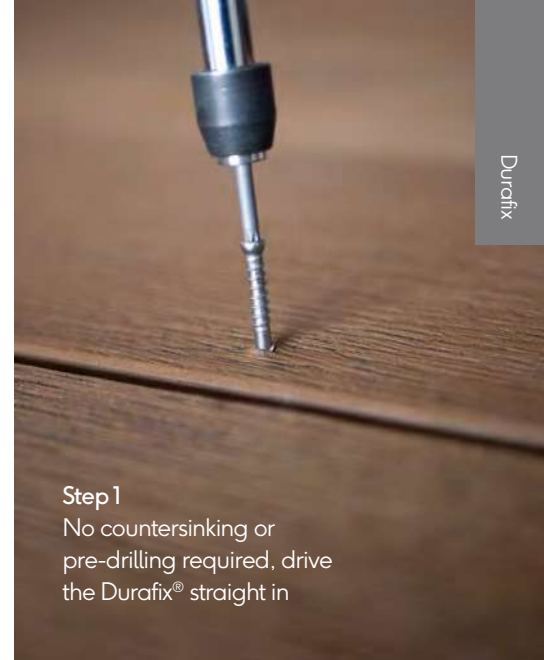

Step 1

No countersinking or pre-drilling required, drive the Durafix® straight in



Step 2

Sink so that the Durafix® head lies approximately 5mm below the surface

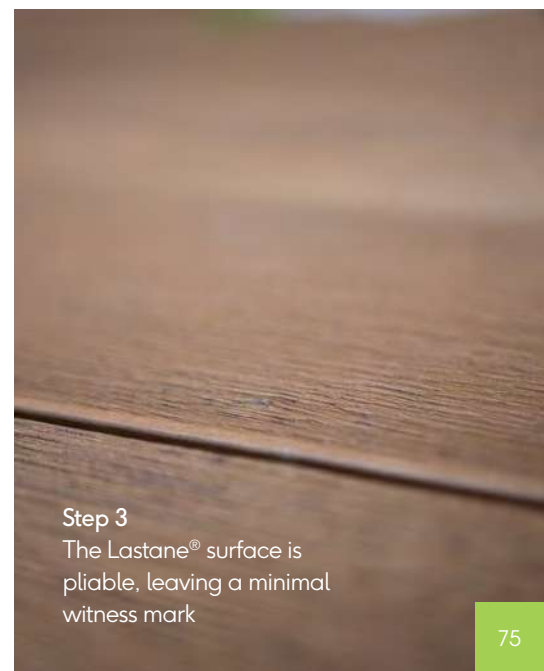

Step 3

The Lastane® surface is pliable, leaving a minimal witness mark

Working Specification

Decking Boards

For all applications we recommend that our boards are installed with a 4mm gap between the boards and a 1mm gap at the butt ends to facilitate drainage. The maximum unsupported overhang for the boards is 50mm and each cut board must be supported by a minimum of three joists. Where a board crosses a joist, two Durafix® fixings will be needed. At the end of the boards, we'd recommend three Durafix® fixings.

Type	Uniform Distributed Load
Commercial applications	$\leq 5\text{kN/m}^2$
Residential applications	$\leq 2.5\text{kN/m}^2$

View the Installation Guide and more:
millboard.co.uk/downloadable-guides

Commercial applications

Joists must support boards at 300mm centres if boards are at 90° to joists. If boards are at 45° then joists need to be set at 240mm centres.

Residential applications

Joists must support boards at 400mm centres if boards are at 90° to joists. If boards are at 45° then joists need to be set at 300mm centres.

Board and Joist Spacing

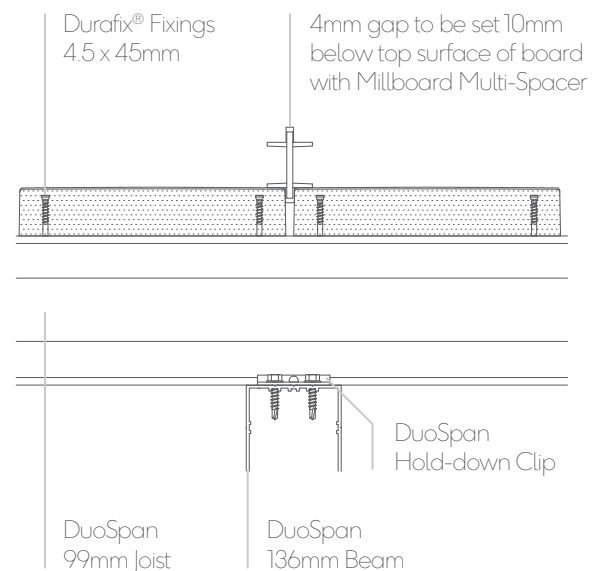
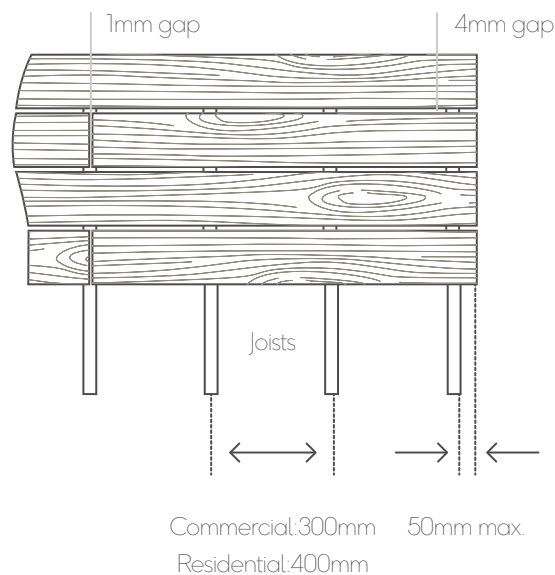

Full installation instructions and videos:
millboard.co.uk/how-to-videos

Full CAD drawings available at:
millboard.co.uk/architect-resources

Working Specification

Edging & Fascia

Millboard edging trims must be supported along their length by a support around the perimeter. Millboard edging trims/fascias must be fixed at 300mm centres along their length, using the Durafix fixings.

Type	Dimensions	Bend radius
Square Edging	50 x 32 x 3200mm	3m
Flexible Bullnose Edging	50 x 32 x 2400mm	1.2m
Fascia Board	146 x 16 x 3200mm	1.2m
Bullnose Board	150 x 32 x 3200mm	Does not bend

View the Installation Guide and more:
millboard.co.uk/downloadable-guides

Colour options

The edge trims are available in nine colours, which can be used to match the decking boards, as a design contrast or to assist partially sighted persons, which is a requirement for some public applications.

Installing Edging & Fascia

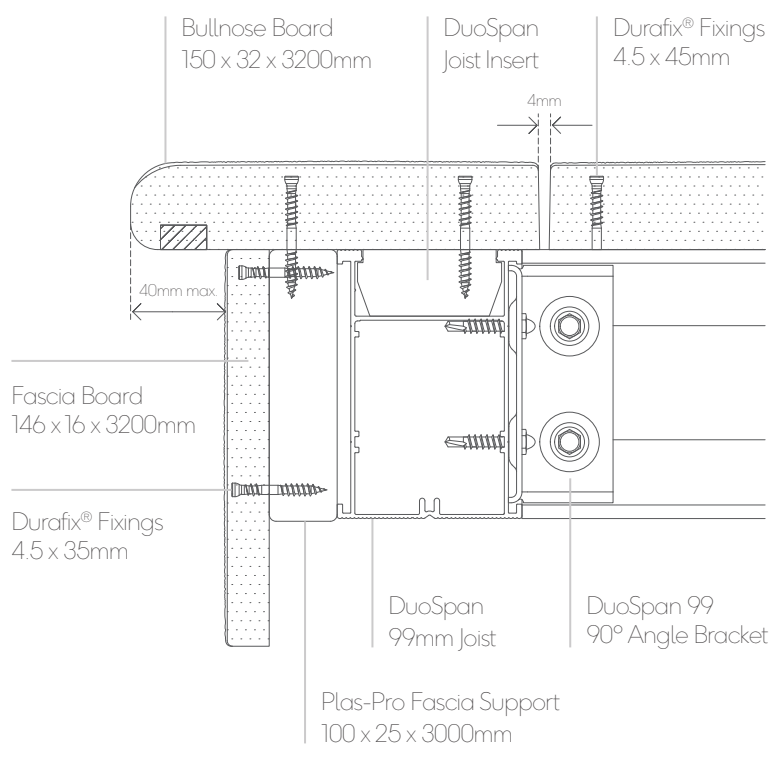

/// Max. recess area for LED strip lighting is 17 x 9mm, up to 11mm from the fascia.

Technical data for all products:
millboard.co.uk/technical-specifications

Creating a curved edge

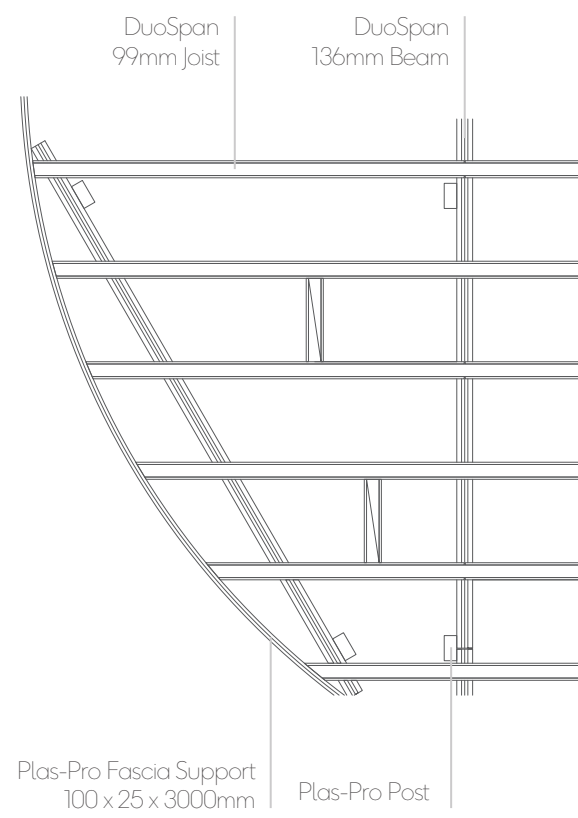

A focus on sustainability

Sustainability is a crucial element of the company's ethos, and we are committed to producing decking that enhances the outdoors without damaging the planet. Millboard products have a low carbon footprint and are made using recycled fillers and biopolymers.

Millboard decking and the processes used to create it have been rigorously tested to ensure there is a minimal impact on the environment. We are proud to be the first premium outdoor flooring company in the world to have its carbon footprint independently verified and UKAS accredited, to the international standard ISO 14064-1 Verified Carbon Footprint Assurance Mark $-1.31\text{kg}/\text{CO}_2$ per m^2 .

Manufacture is carried out here in the UK, so transport costs are lower than for imported hardwood or composite decking, further helped by our use of lightweight, recyclable packaging.

Millboard decking puts no pressure on the world's hardwood forests, and its durability also leads to fewer demands on global resources. Our boards require minimal maintenance, and there's no need to use potentially harmful cleaners or preservatives.

For more about our approach to sustainability, see our brochure 'A sustainable choice', available at millboard.co.uk/downloadable-guides

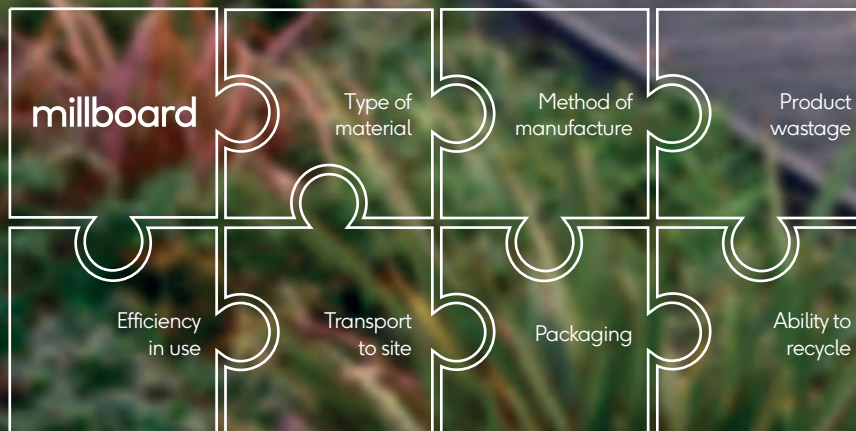

Maintenance

Millboard decking achieves superior outdoor spaces. Our boards perfectly mimic the beauty of natural wood and provide a practical, low-maintenance surface, leaving you free to simply enjoy life outdoors.

Our innovative decking gives you the assurance of high slip-resistance and zero chance of rotting without the need for intensive maintenance. A simple wash clean is all it needs.

Living with Millboard decking

Millboard decking's stunning good looks require minimal maintenance. Our Lastane® surface is resistant to scratches, food and drink stains, and is built for everyday use.

Here are a few simple maintenance tips:

- Remove spills and marks with plenty of water, a mild detergent and a cloth or brush (no solvents, chemicals or abrasive cleaners needed). Strong dyes and stains that fall on your decking, such as berries and animal droppings, should not be left. Remove these as soon as possible to prevent marking.
- Stubborn marks may be removed with a range of different cleaners depending on the mark. Please contact us for more information.
- Take care when moving sharp objects across your decking to avoid marking, e.g. unprotected table or chair legs, spiked shoes or metal planter bases.
- Use a small amount of granulated white salt (not rock salt) to tackle ice in the winter, and simply wash it off with soapy water and a brush once the weather warms up.
- Clean your decking when required to remove leaves and general dirt particles; this can be done with warm, soapy water and a brush.

If you have any queries or concerns regarding your Millboard decking, please email us at enquiries@millboard.co.uk, or call our UK support team on 024 7643 9943

Further information and warranty registration:
millboard.co.uk/warranty-registration



Alternative Uses

Landscapers and gardeners everywhere are discovering that Millboard decking's versatility and durability makes it very suitable for seating arrangements, planters, gates and eating areas.

As Millboard decking can be mitred and glued using PU wood adhesive, it makes it very easy to create a seamless masterpiece.

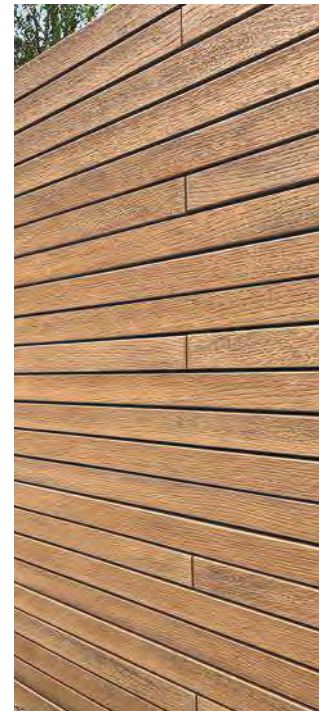



Millboard products have previously been used in a variety of ways including:

- Bridges
- Feature walls
- Residential cladding
- Gates
- Planters
- Pond surrounds
- Pool surrounds
- Seating
- Table-tops
- Tree houses

Find inspiration for your next project at:
millboard.co.uk/design-inspiration



Above Dovetail Timber Homes



Credit: SHH Architects / MY Construction

Selection and Visualisation

Choosing your Millboard deck is a significant decision and one that you will want to get right. We make it easy to confirm your choice, with appointed distributors across the UK holding stocks of the Millboard range available for you to view.

Nothing beats seeing and walking on a Millboard deck for real, but we're happy to send you some free samples so that you can experience the unique colours and grain textures up close.

Order a free sample pack: millboard.co.uk/samples



Ordering and Installation

Purchasing your Millboard deck is simple. Appointed stocking distributors across the UK and beyond are available to assist you and to help you to fulfil your requirements. Should you have any difficulty locating a distributor in your area, please contact our team who will gladly direct you. Where assistance is required on planning larger projects, our technical team can provide in-depth support with both design and practical considerations.

Millboard decking is straightforward to install. However, we'd recommend using an experienced contractor – our list of trained and approved installers covers most areas of the UK.

Find an Approved Installer or stockist: millboard.co.uk/locator



London Design Hub

Situated in the heart of the creative community, our showroom reflects Millboard's commitment to remain at the forefront of outdoor design progression, and incorporates dedicated space for CPD training sessions and design-focused events.

The London Design Hub features the full range of Millboard decking, and includes striking displays of the many creative ways in which Millboard can be used – both innovative laying styles and alternative uses in creating steps, planters, water features and more.

63 Goswell Road, Clerkenwell
London, EC1V 7EN
020 39 788 800

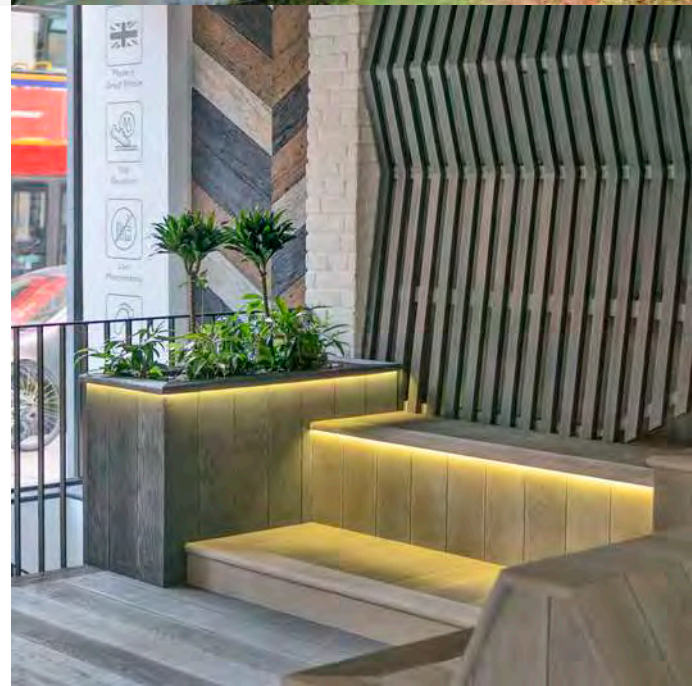

Select your Millboard decking

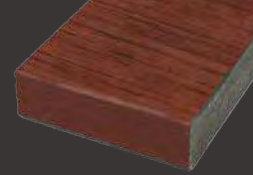

Enhanced Grain

Weathered Oak

176 x 3600 x 32mm

200 x 3600 x 32mm

Antique Oak
Page 12

MDE176A

—

Smoked Oak
Page 14

MDE176D

—

Brushed Basalt
Page 16

MDE176B

—

Limed Oak
Page 18

MDE176L

—

Burnt Cedar
Page 20

MDE176R

—

Golden Oak
Page 22

MDE176G

—

Coppered Oak
Page 24

MDE176C

—

Jarrah
Page 26

MDE176J

—

Vintage
Page 38

—

MDW200V

Driftwood
Page 40

—

MDW200D

Embered
Page 42

—

MDW200R

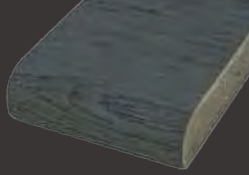
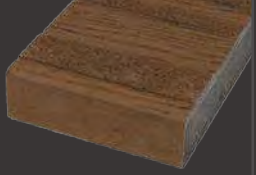

Lasta-Grip

200 x 3600 x 32mm

Bullnose Board

150 x 3200 x 32mm

Flexible Bullnose Edging

50 x 2400 x 32mm

Square Edging

50 x 3200 x 32mm

Fascia Board

146 x 3200 x 16mm

—	MEBB150A	MEBF50A	MEUN32A	MFN320A
—	MEBB150D	MEBF50D	MEUN32D	MFN320D
—	MEBB150B	MEBF50B	MEUN32B	MFN320B
—	MEBB150L	MEBF50L	MEUN32L	MFN320L
—	MEBB150R	MEBF50R	MEUN32R	MFN320R
MDL200G	MEBB150G	MEBF50G	MEUN32G	MFN320G
MDL200C	MEBB150C	MEBF50C	MEUN32C	MFN320C
—	MEBB150J	MEBF50J	MEUN32J	MFN320J
—	MEBB150V	MEBF50V	MEUN32V	MFN320V
—	MEBB150D	MEBF50D	MEUN32D	MFN320D
—	MEBB150R	MEBF50R	MEUN32R	MFN320R

These swatches are representative only; due to the replications of natural hardwood, the complete deck may have slight variations in colour tone and graining.

millboard.co.uk

The Millboard Company Ltd
UK Head Office
Castle Court
Bodmin Road
Coventry CV2 5DB

T +44 (0) 24 7643 9943
F +44 (0) 24 7661 1668
E enquiries@millboard.co.uk

Company registered No. 06061318
VAT No: 980 616602
Brochure edition: 2021

